

Ventana corredera 2 hojas

CP99

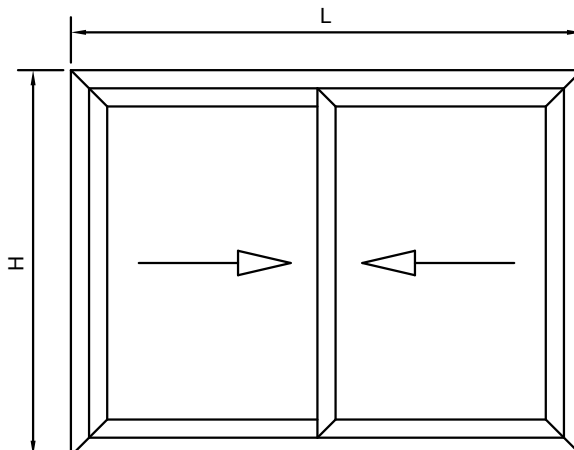

	Referencia	Uds	Medida	Corte
	M-3286	2	L	HORZ.
	M-3286	2	H-2	VERT.
	M-3287	4	L/2-15	HORZ.
	M-3287	4	H-86	VERT.
	M-3288	2	H-86	VERT.
	M-3289	1	L	HORZ.

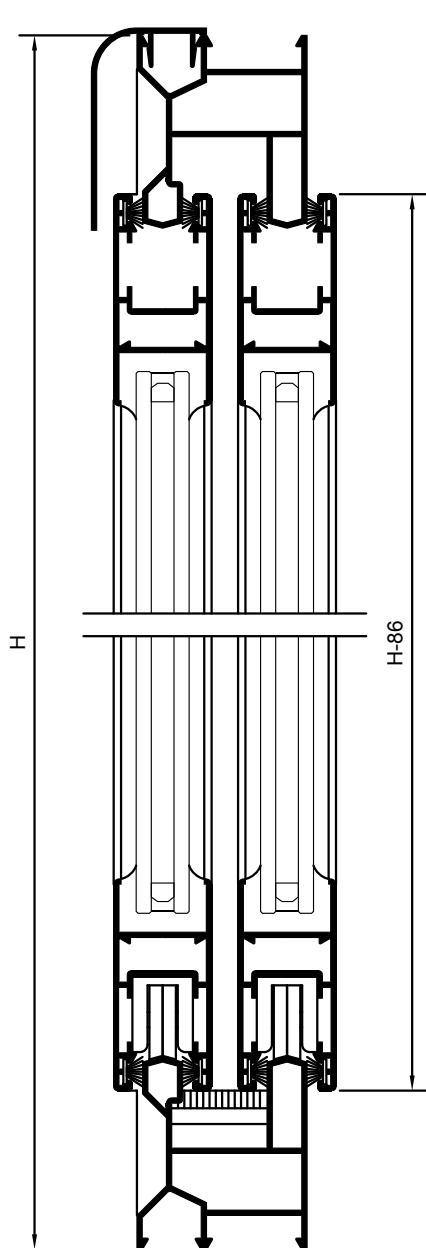
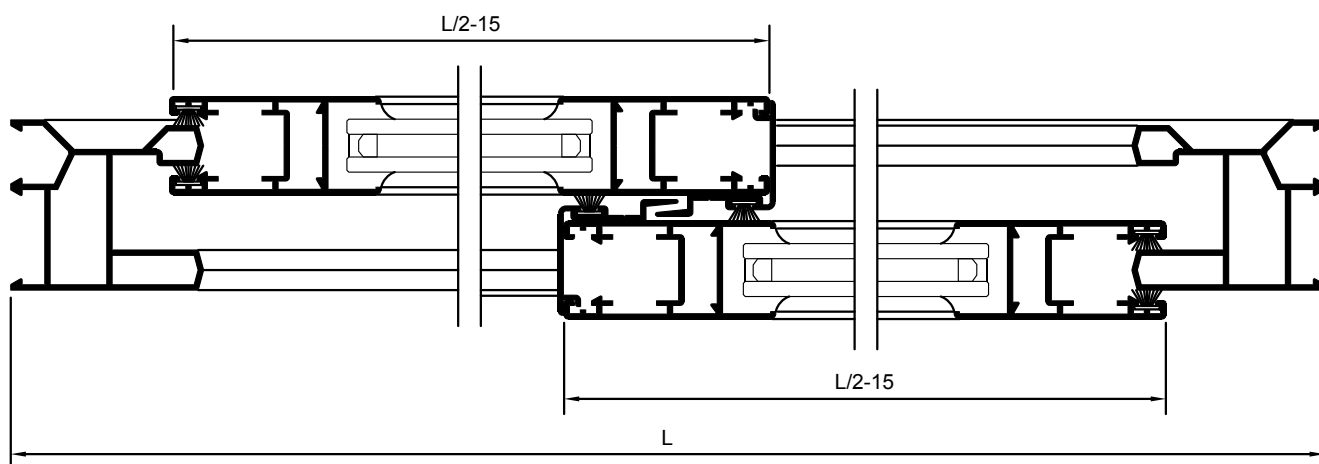

NOTA: Las medidas indicadas son orientativas, pudiendo variar según el tipo de herraje. Rogamos verifiquen las mismas antes de cortar material en serie.



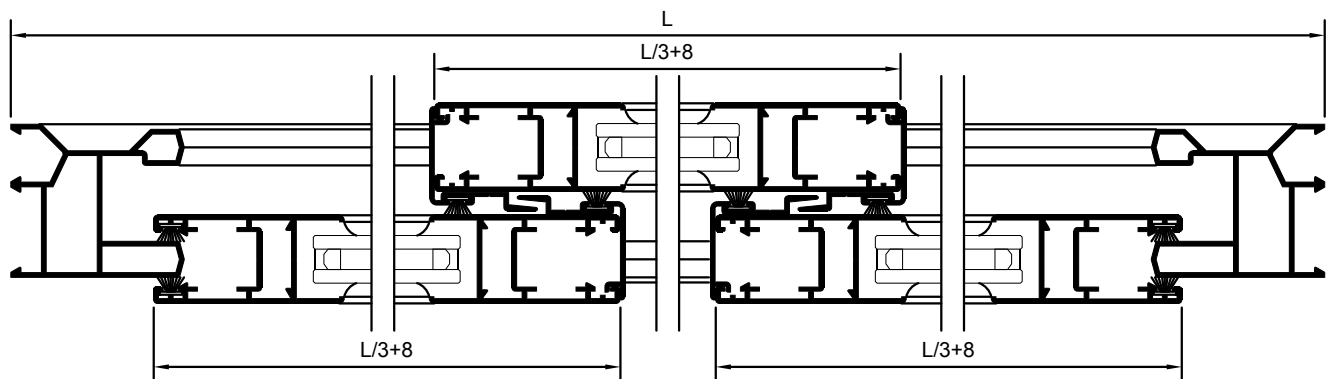
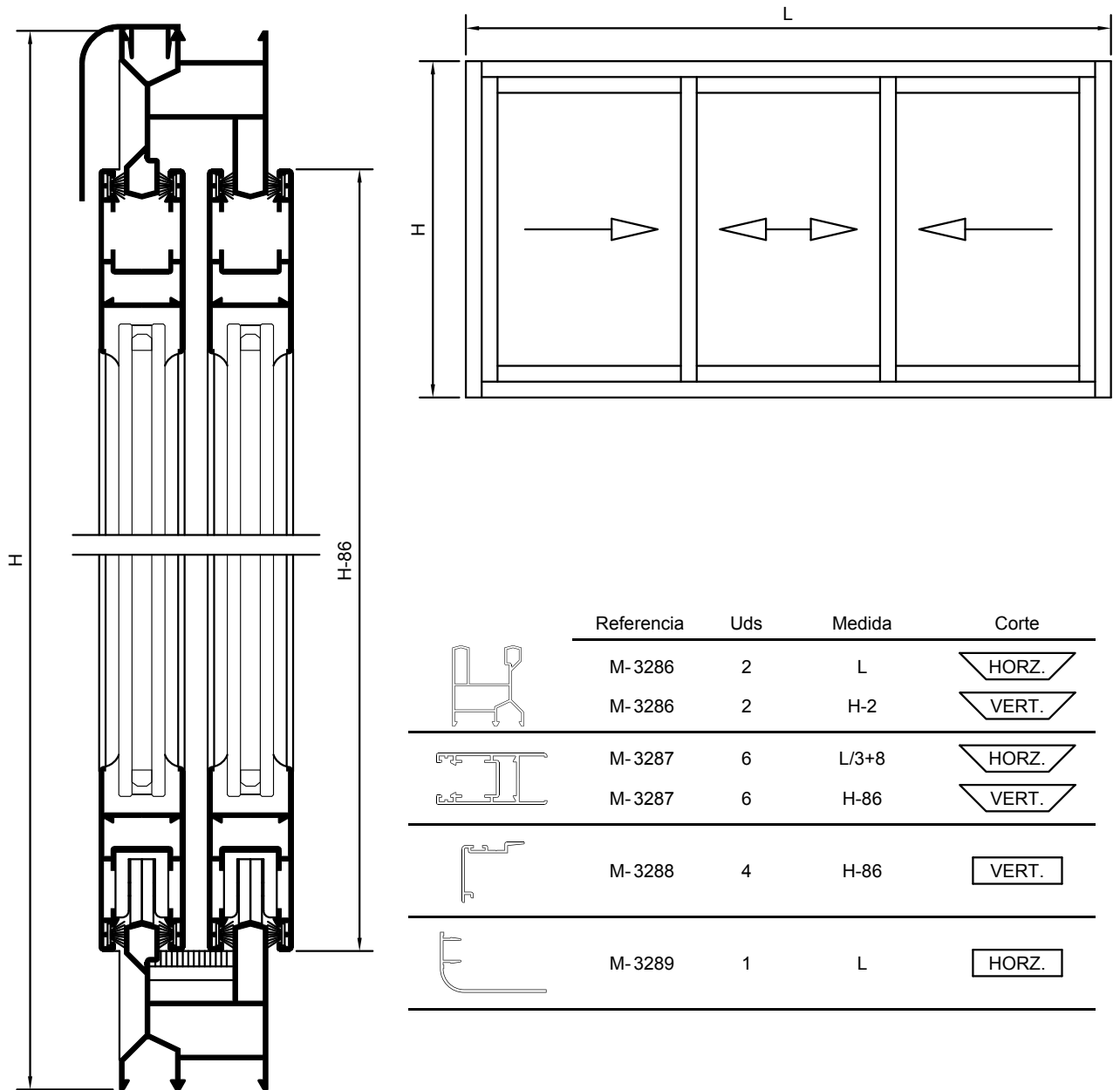





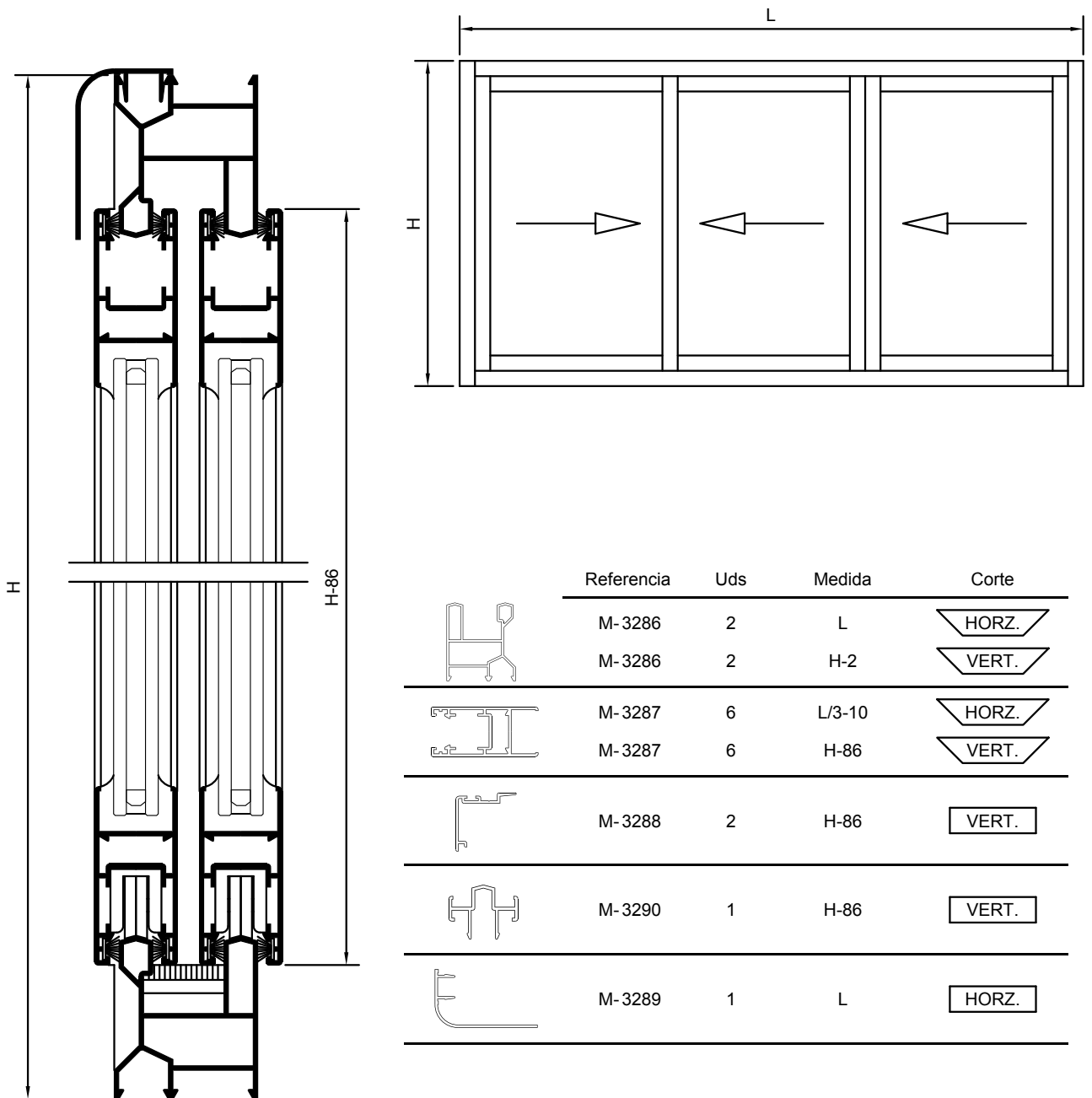

Ventana corredera 3 hojas CP99

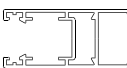

NOTA: Las medidas indicadas son orientativas, pudiendo variar según el tipo de herraje. Rogamos verifiquen las mismas antes de cortar material en serie.

Ventana corredera 3 hojas CP99

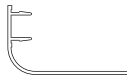



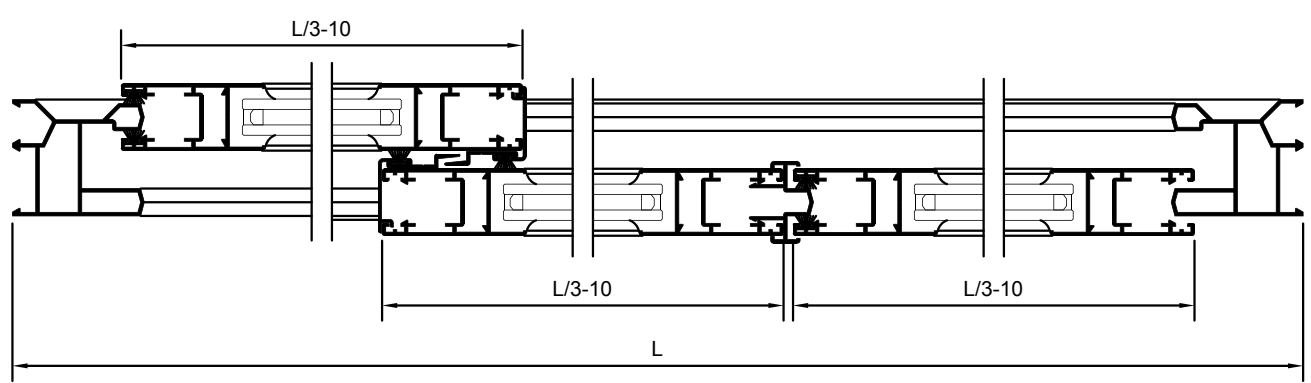

	Referencia	Uds	Medida	Corte
	M-3286	2	L	 HORZ.
	M-3286	2	H-2	 VERT.
	M-3287	6	L/3-10	 HORZ.
	M-3287	6	H-86	 VERT.
	M-3288	2	H-86	 VERT.
	M-3290	1	H-86	 VERT.
	M-3289	1	L	 HORZ.

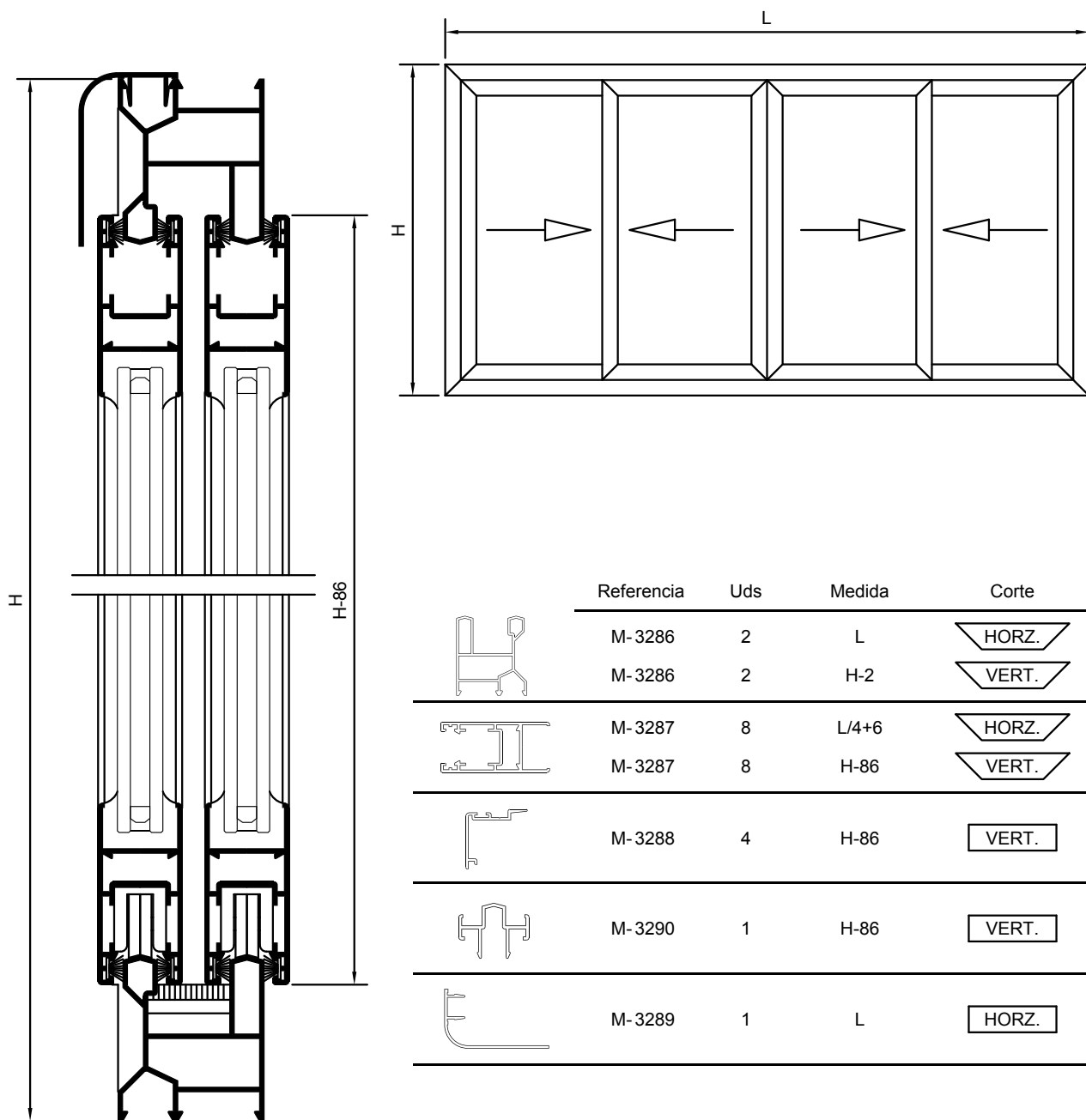

NOTA: Las medidas indicadas son orientativas, pudiendo variar según el tipo de herraje. Rogamos verifiquen las mismas antes de cortar material en serie.

Ventana corredera 4 hojas CP99

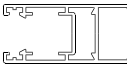

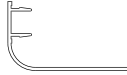
	Referencia	Uds	Medida	Corte
	M-3286	2	L	HORZ.
	M-3286	2	H-2	VERT.
	M-3287	8	L/4+6	HORZ.
	M-3287	8	H-86	VERT.
	M-3288	4	H-86	VERT.
	M-3290	1	H-86	VERT.
	M-3289	1	L	HORZ.

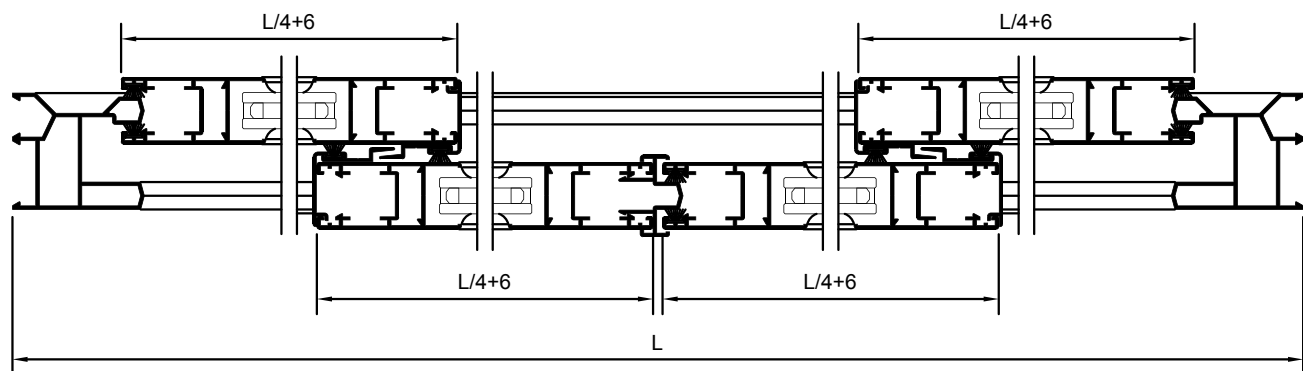

NOTA: Las medidas indicadas son orientativas, pudiendo variar según el tipo de herraje. Rogamos verifiquen las mismas antes de cortar material en serie.

Ventana corredera 2 h. y fijo CP99

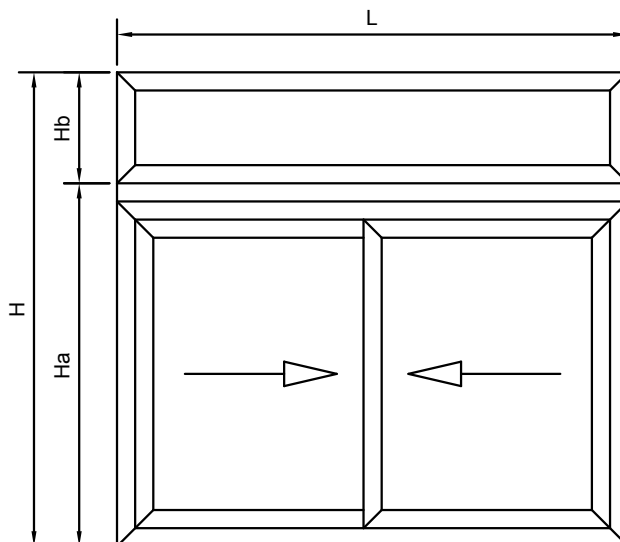
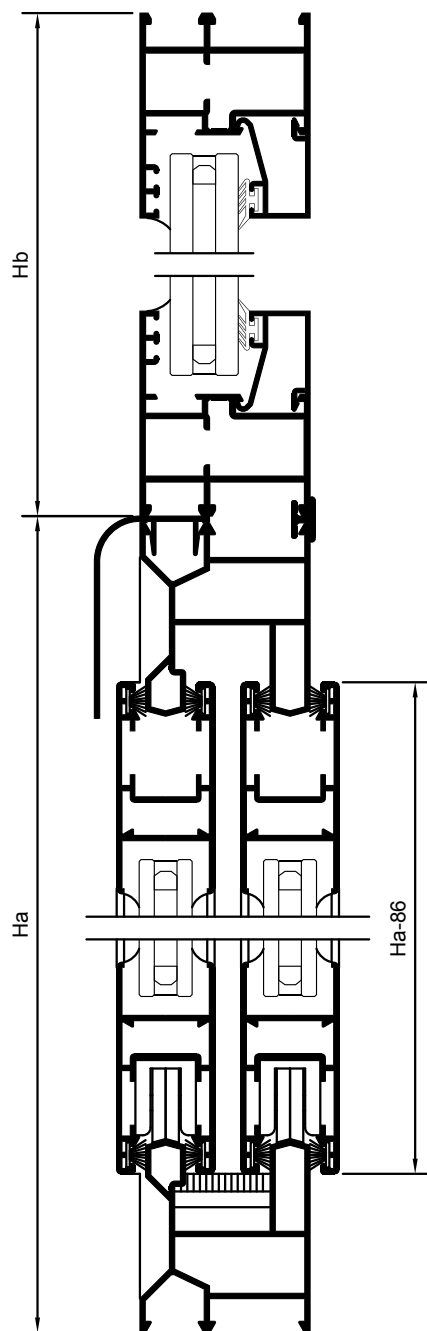

	Referencia	Uds	Medida	Corte
	M-3286	2	L	HORZ.
	M-3286	2	Ha-2	VERT.
	M-3287	4	L/2-15	HORZ.
	M-3287	4	Ha-86	VERT.
	M-3288	2	Ha-86	VERT.
	M-3289	1	L	HORZ.
	M-1995	2	L	HORZ.
	M-1995	2	Hb	VERT.
	M-2384	2	CORTAR DESPUÉS DE ARMADO	HORZ.
	M-2384	2		VERT.

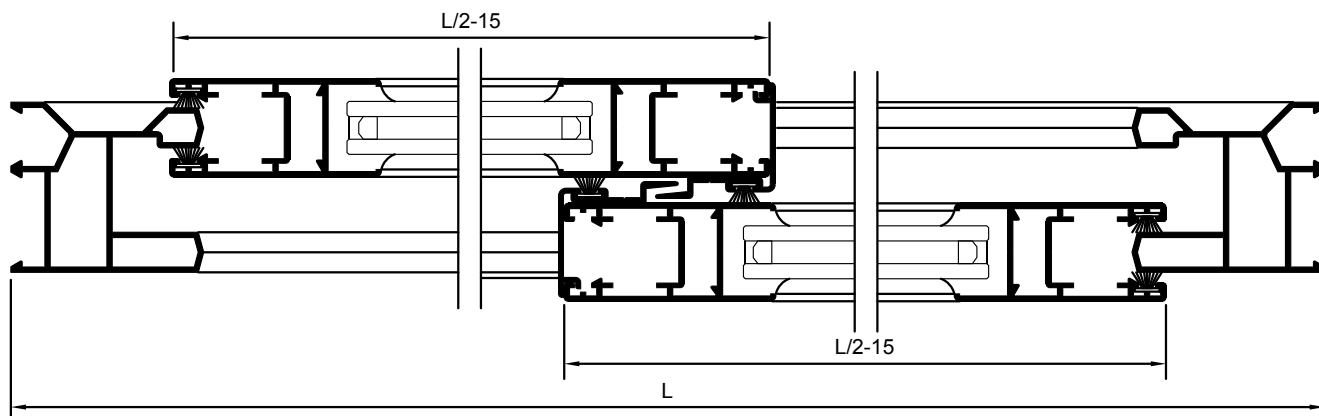

NOTA: Las medidas indicadas son orientativas, pudiendo variar según el tipo de herraje. Rogamos verifiquen las mismas antes de cortar material en serie.