

Nudo Lateral

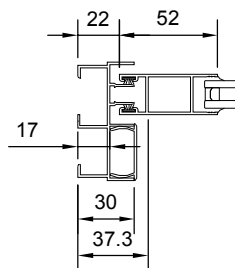

Nudo Inferior

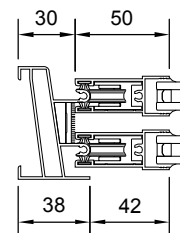

Nudo Superior

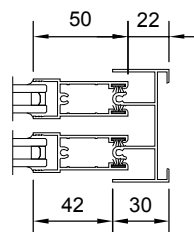

Nudo Central

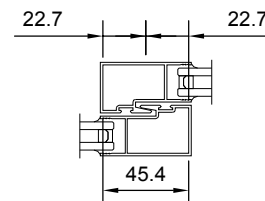

Cierre 4 hojas

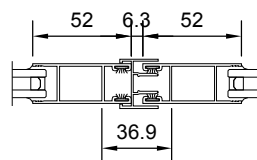

Fijo

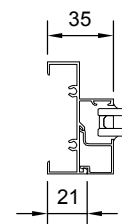

Nudo Fijo Superior

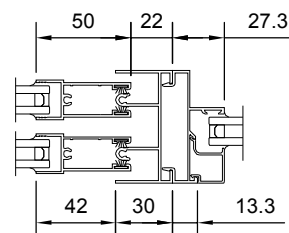

Descripción

- Carpintería corredera montada a 90°
- Marco de 59.5 mm y hoja de 21.1 mm.
- Espesor medio en marcos y hojas de 1.3 mm.
- Juntas de estanqueidad con burletes..
- Huevo de acristalamiento de 8 y 18.5 mm.

Ensayos Marcado CE

Medidas de ensayos: 1.380x1.770 mm: 2.44 m²

AIRE	2
AGUA	6A
VIENTO	C4
TÉRMICA	U _w = 3.2W/m ²
ACÚSTICA	R _w 22(0;-1) dB

Transmitancia térmica calculada para carpintería de 4.31 m² con vidrio bajo emisivo 4/16/4

Atenuación acústica para carpintería con una superficie inferior a 3.10 m²

Aperturas

Ventanas

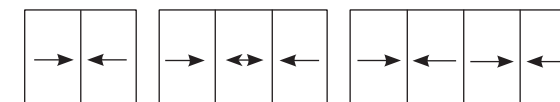

2 Hojas

3 Hojas

4 Hojas

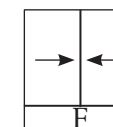

2 Hojas con Fijo

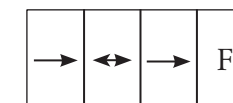

3 Hojas con Fijo

Perfiles EURO 1000

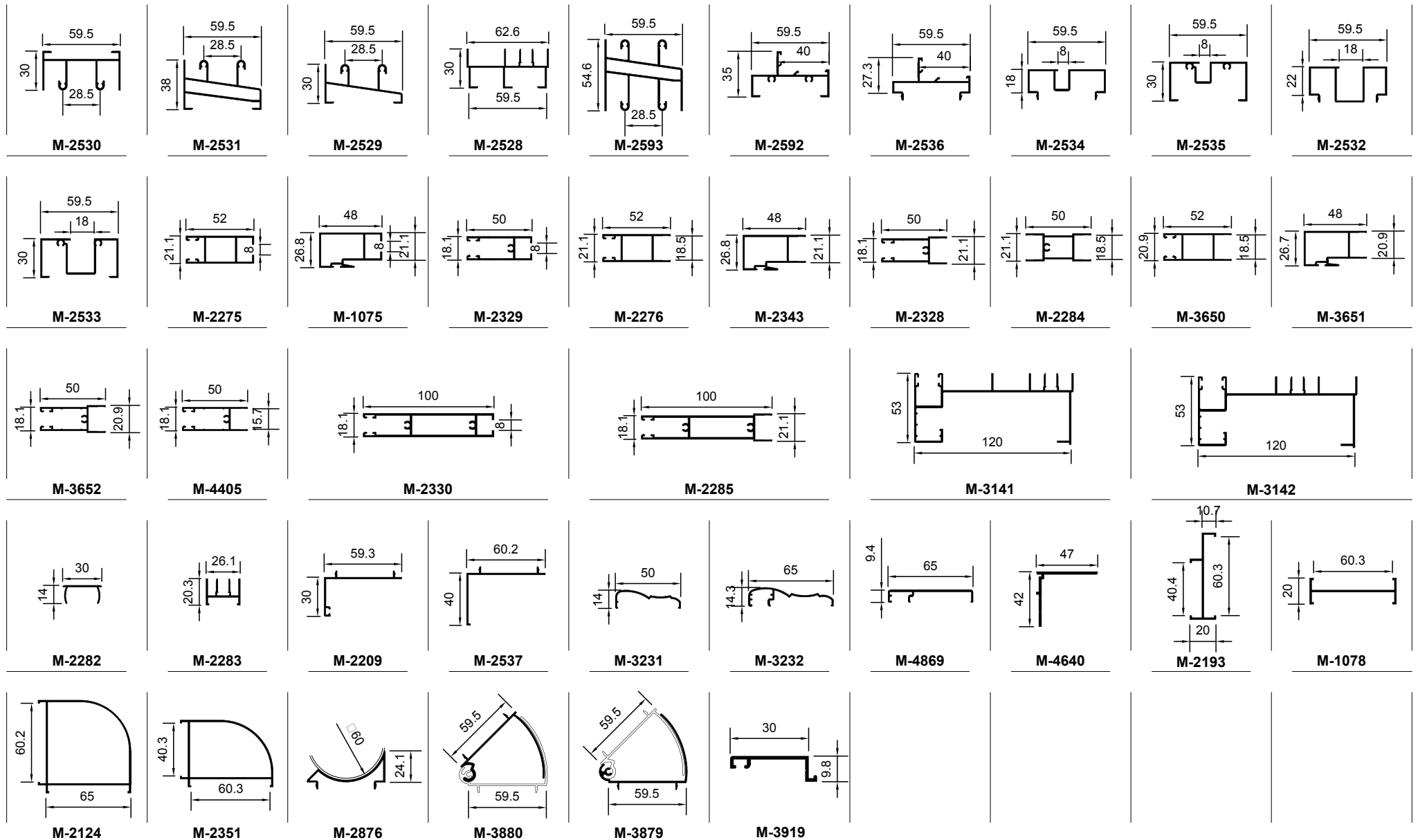

Secciones EURO 1000

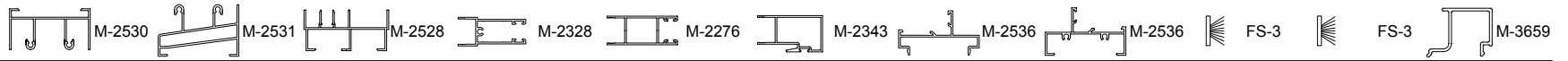

NOTA: Las medidas indicadas son orientativas, pudiendo variar según el tipo de herraje. Rogamos verifiquen las mismas antes de cortar material en serie.

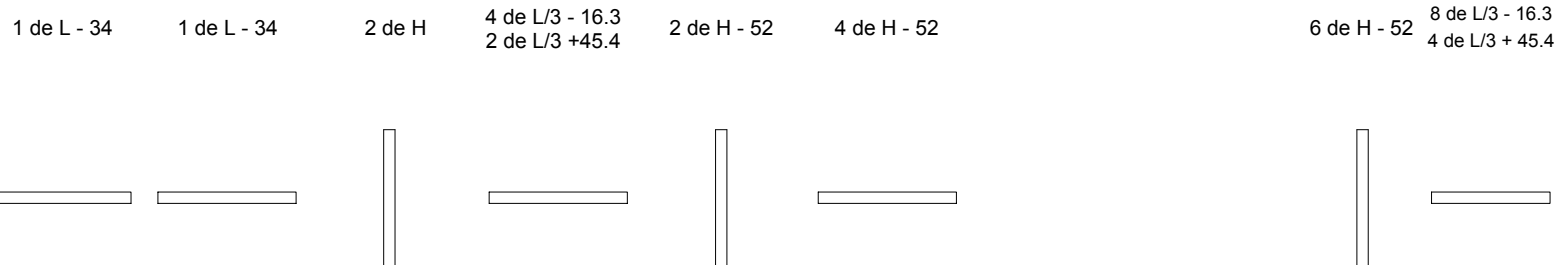
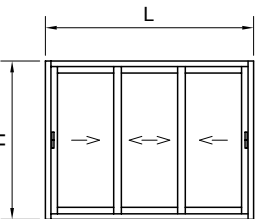
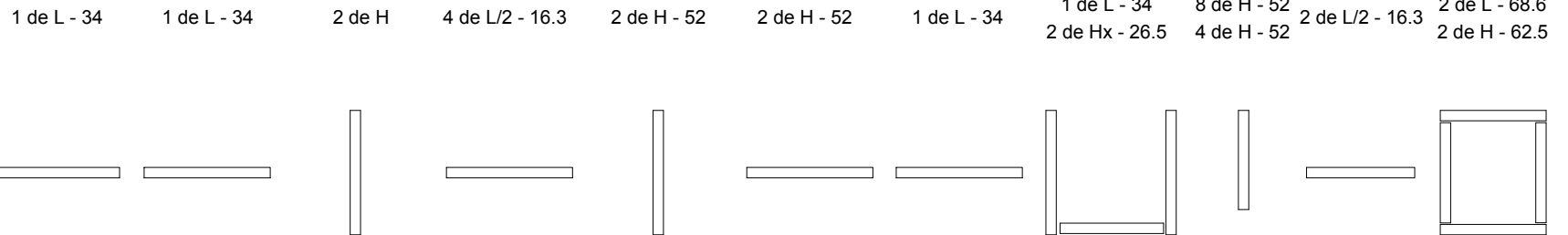
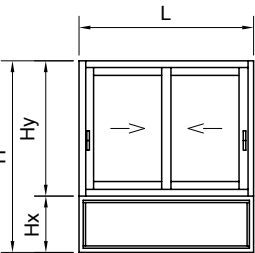
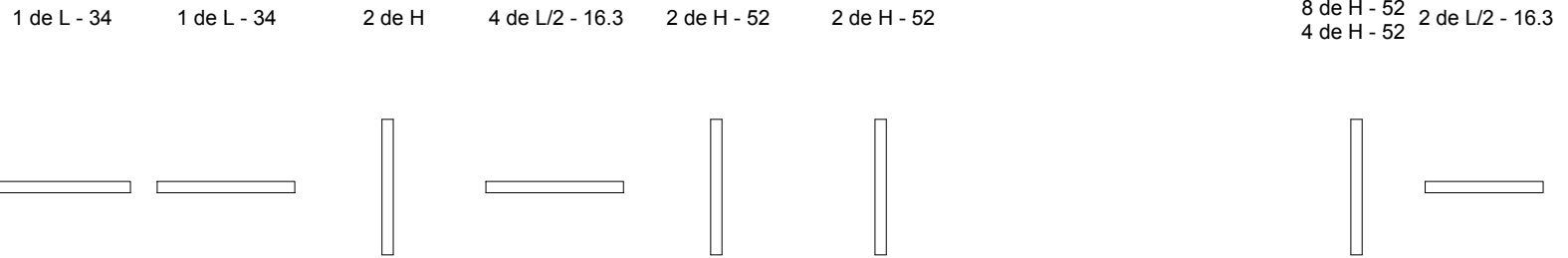
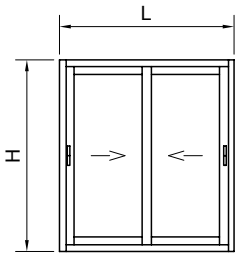

Secciones EURO 1000

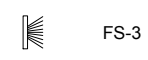
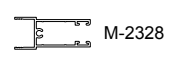
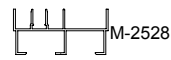

NOTA: Las medidas indicadas son orientativas, pudiendo variar según el tipo de herraje. Rogamos verifiquen las mismas antes de cortar material en serie.

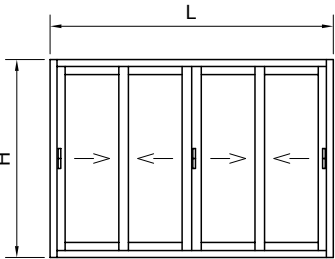

1 de L - 34

1 de L - 34

2 de H

4 de L/4 - 16.3
4 de L/4 + 21.7

2 de H - 52

4 de H - 52

10 de H - 52

8 de L/4 - 16.3
8 de L/4 + 21.7

