

# INTRODUCCIÓN

## SISTEMAS LATERALES ABATIBLES



**HYDRO**

Sistema completo para laterales abatibles y fijos basado en un acoplamiento de perfiles de montaje rápido y seguro. No se precisa ninguna otra operación de ensamblaje. Eliminan las vibraciones del lateral en movimiento.

Obtenemos:

- Ligereza.
- Alto momento de inercia de los perfiles.
- Facilidad de insertar juntas protectoras y de estanqueidad.
- Acabado superficial anodizado o lacado.
- Alto valor de recuperación del material empleado.

# HOJA DE MONTAJE

## SISTEMAS LATERALES ABATIBLES



HYDRO

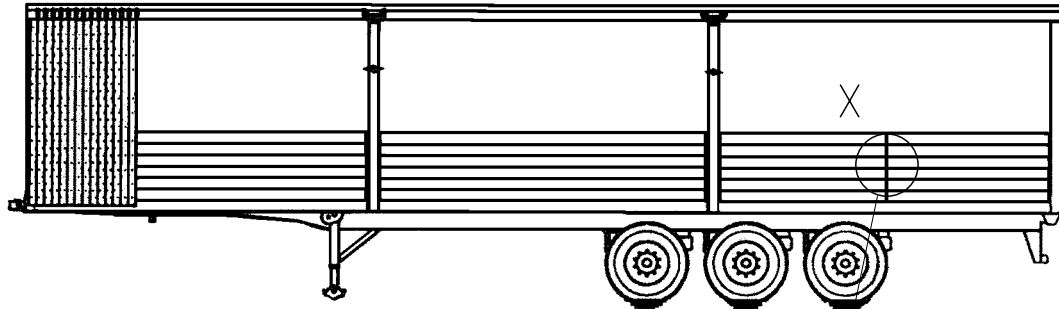

**E-7632**  
Perfil apilable con  
alojamiento de  
mecanismos y junta  
de goma

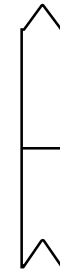

**E-7210**  
Perfil apilable

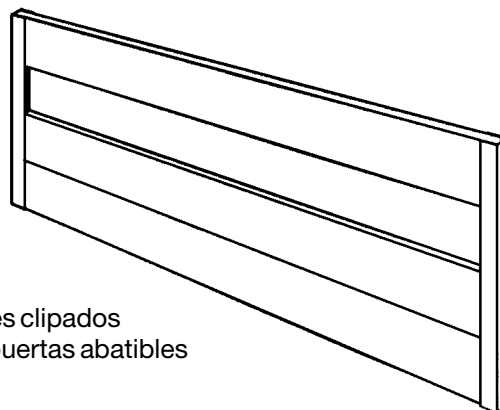
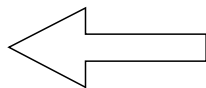
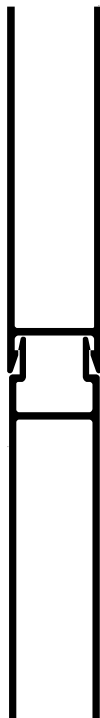
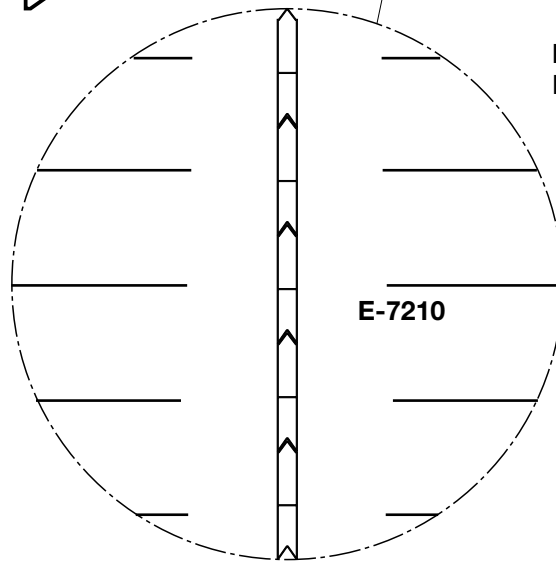

Perfiles clipados  
para puertas abatibles

# HOJA DE MONTAJE

## SISTEMAS LATERALES ABATIBLES



HYDRO

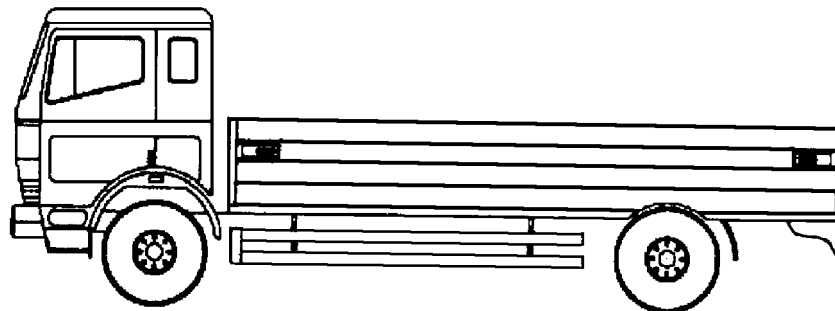

E-7507



E-7505



E-7504



E-60023



E-5470



E-5530

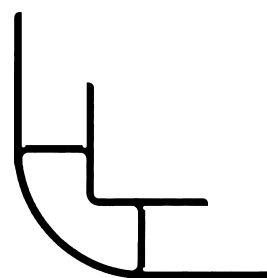

E-60050

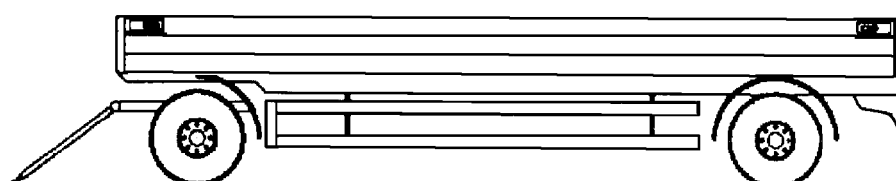

# PERFILES

## SISTEMAS LATERALES ABATIBLES



HYDRO

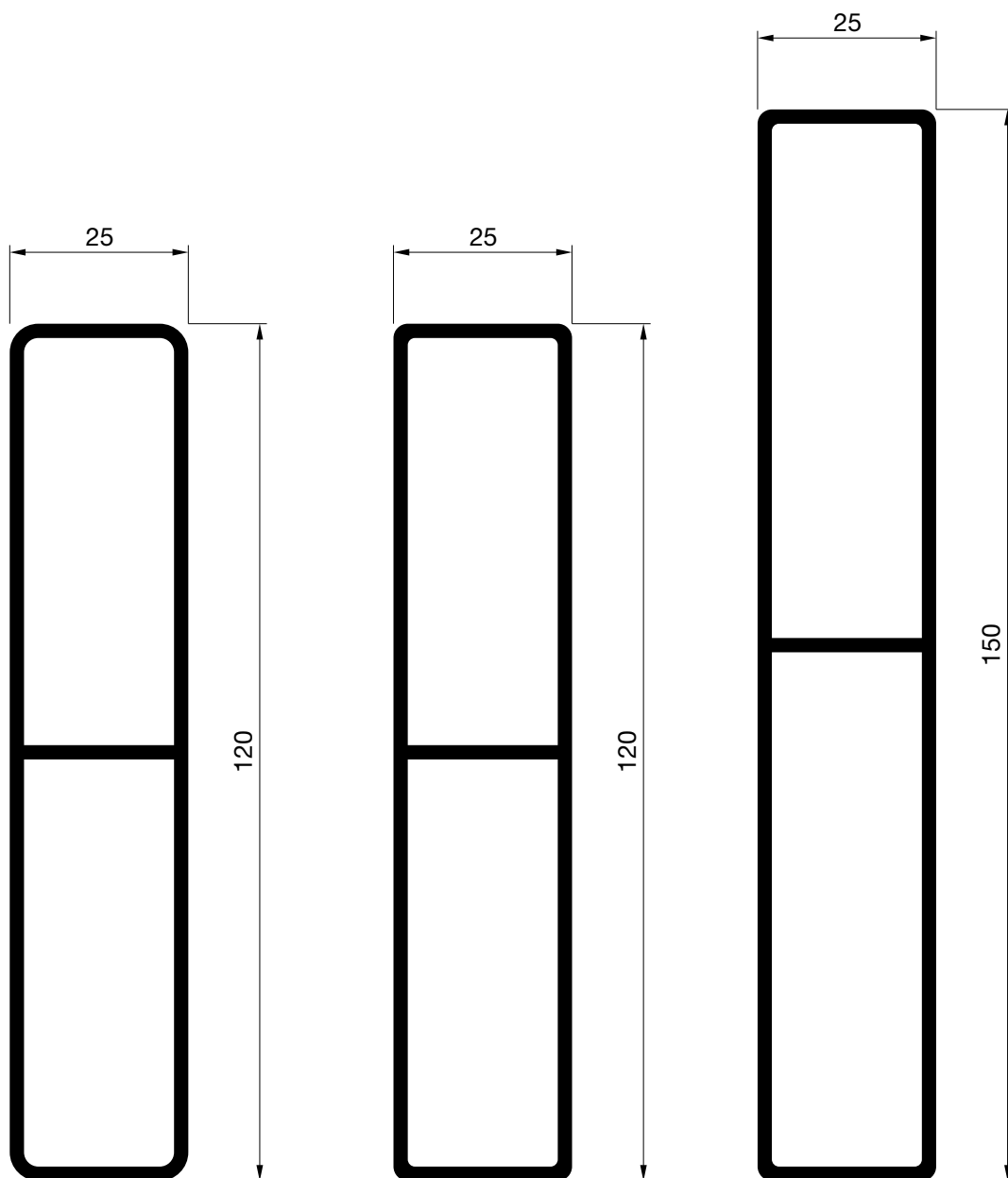

### **E-5458**

Peso: 1601 gr/m.  
P. Total: 587 mm.

### **E-7211**

Peso: 1231 gr/m.  
P. Total: 605 mm.

### **E-60030**

Peso: 1474 gr/m.  
P. Total: 725 mm.

# PERFILES

## SISTEMAS LATERALES ABATIBLES



HYDRO

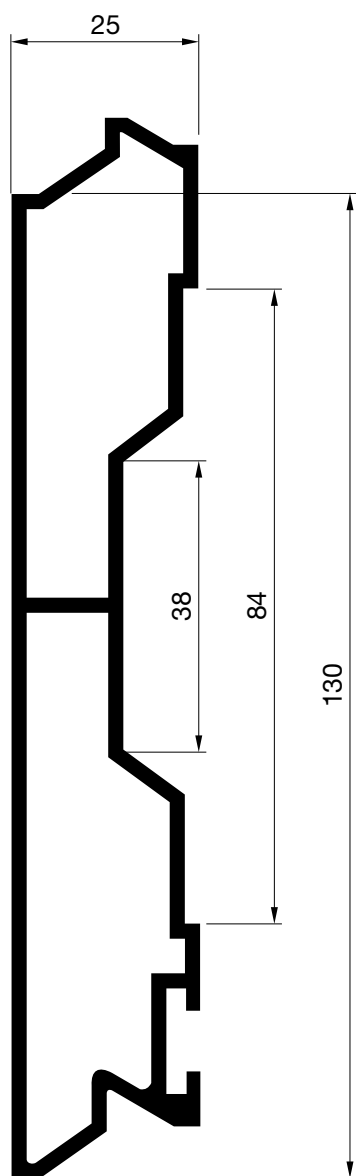

**E-7632**

Peso: 1751 gr/m.  
P. Total: 695 mm.

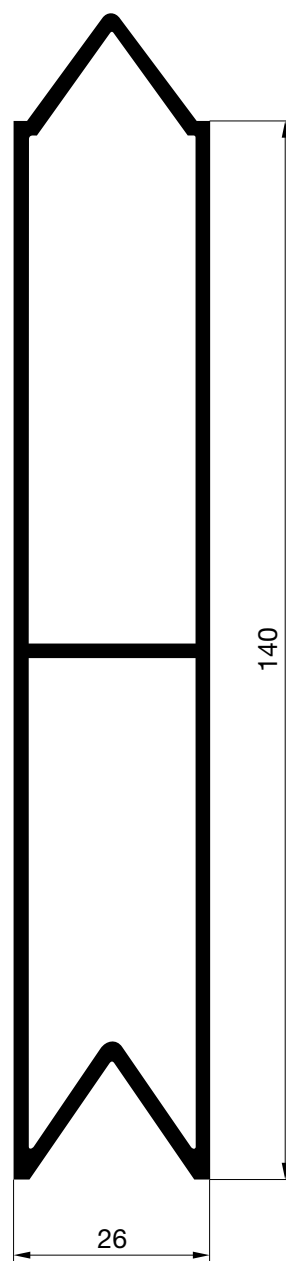

**E-7210**

Peso: 1539 gr/m.  
P. Total: 749 mm.

# PERFILES

## SISTEMAS LATERALES ABATIBLES



HYDRO

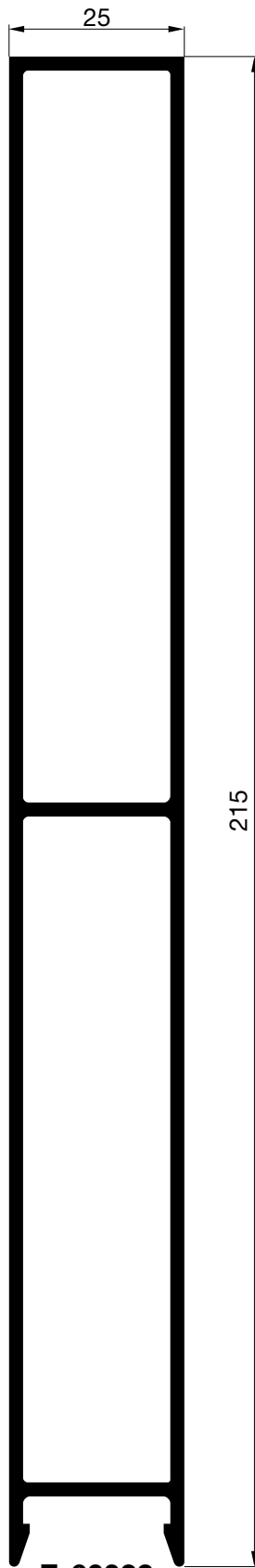

**E-60022**  
Peso: 2355 gr/m.  
P. Total: 980 mm.

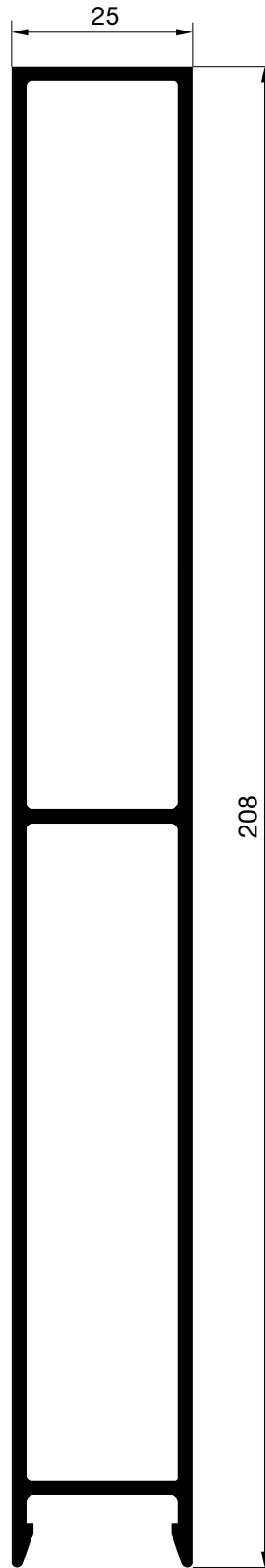

**E-7504**  
Peso: 2395 gr/m.  
P. Total: 951 mm.

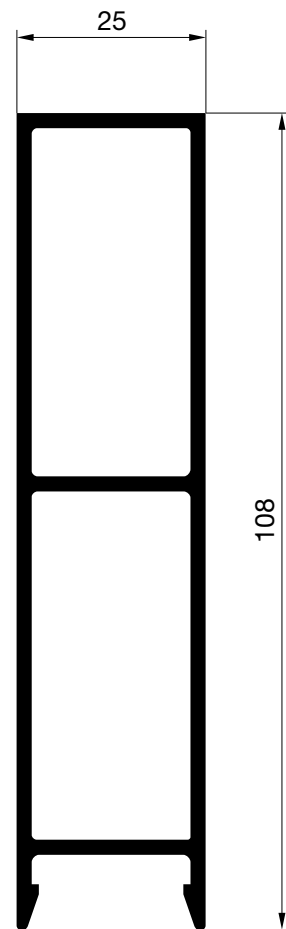

**E-60063**  
Peso: 1423 gr/m.  
P. Total: 551 mm.

# PERFILES

## SISTEMAS LATERALES ABATIBLES



HYDRO

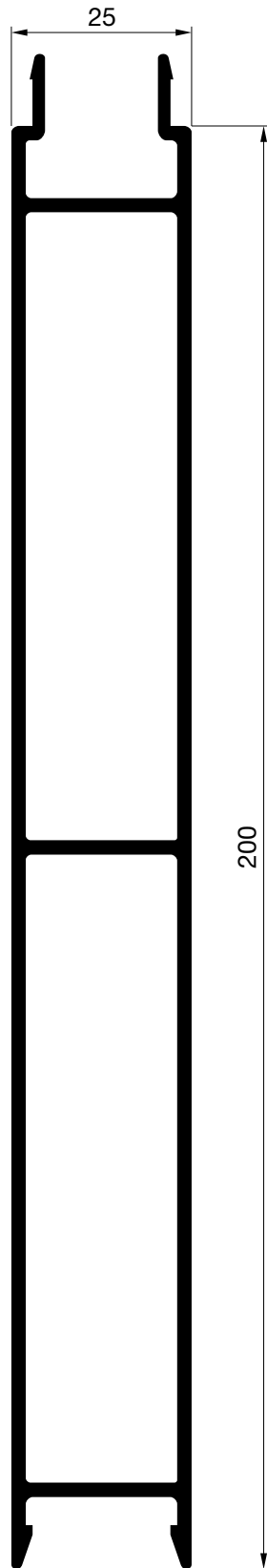

**E-7505**  
Peso: 2686 gr/m.  
P. Total: 965 mm.

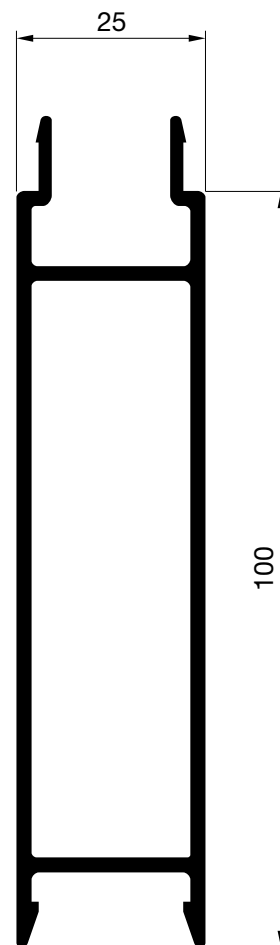

**E-7684**  
Peso: 1365 gr/m.  
P. Total: 528 mm.

# PERFILES

## SISTEMAS LATERALES ABATIBLES



HYDRO

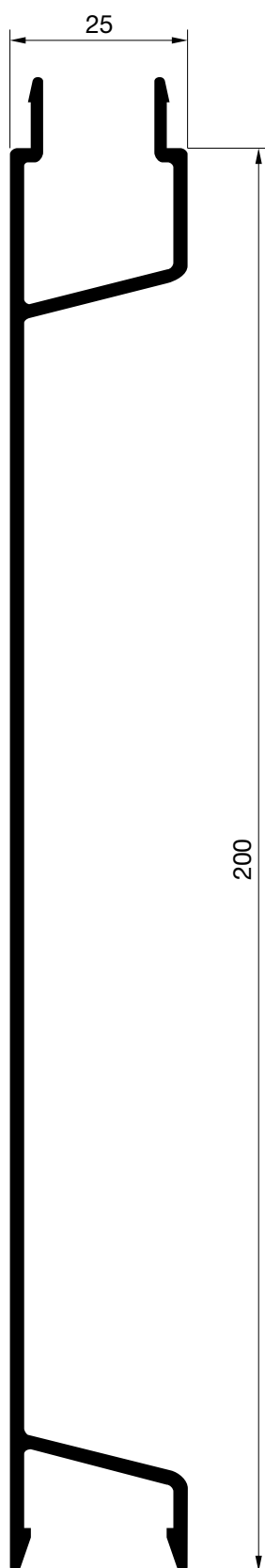

**E-7507**

Peso: 1593 gr/m.  
P. Total: 588 mm.

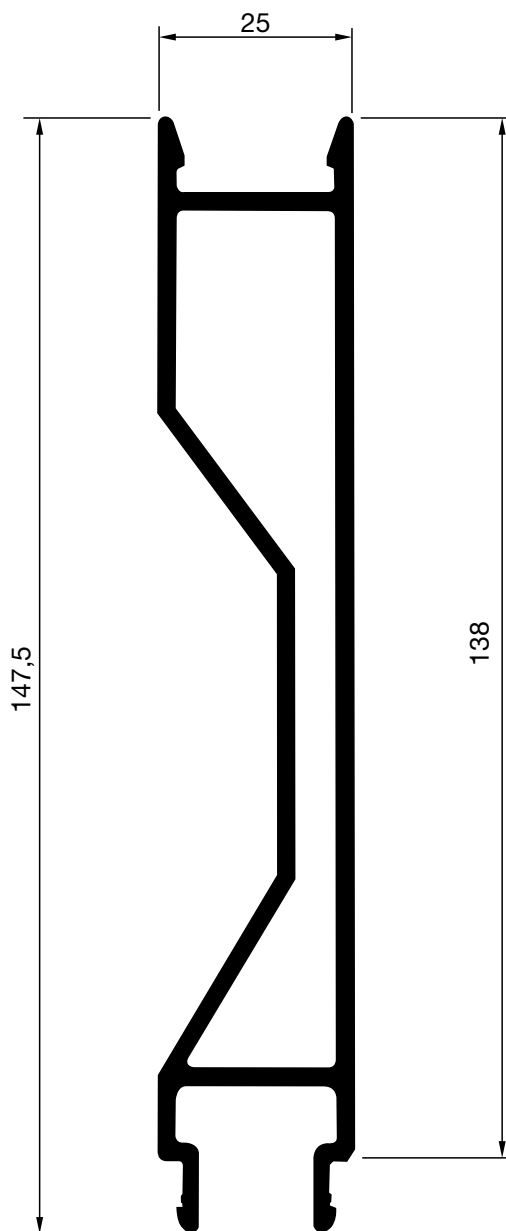

**E-60097**

Peso: 1776 gr/m.  
P. Total: 697 mm.

# PERFILES

## SISTEMAS LATERALES ABATIBLES



HYDRO

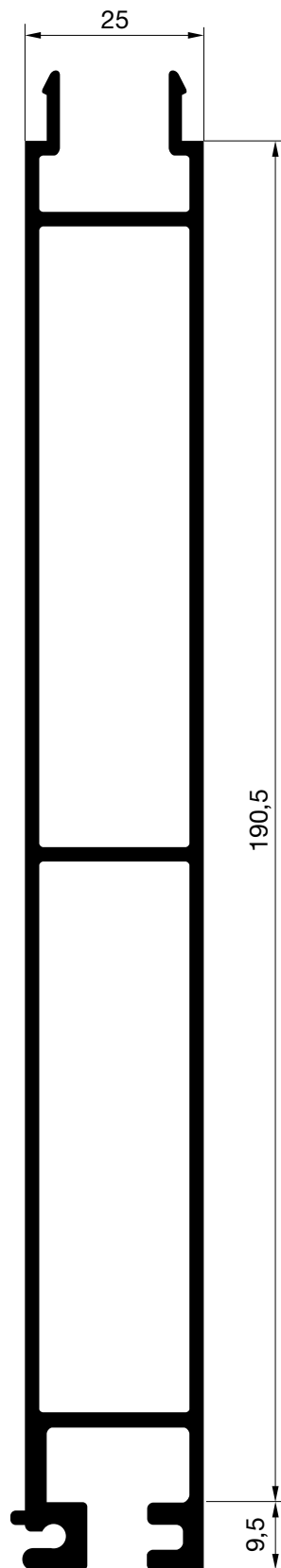

**E-7506**

Peso: 2650 gr/m.  
P. Total: 1009 mm.

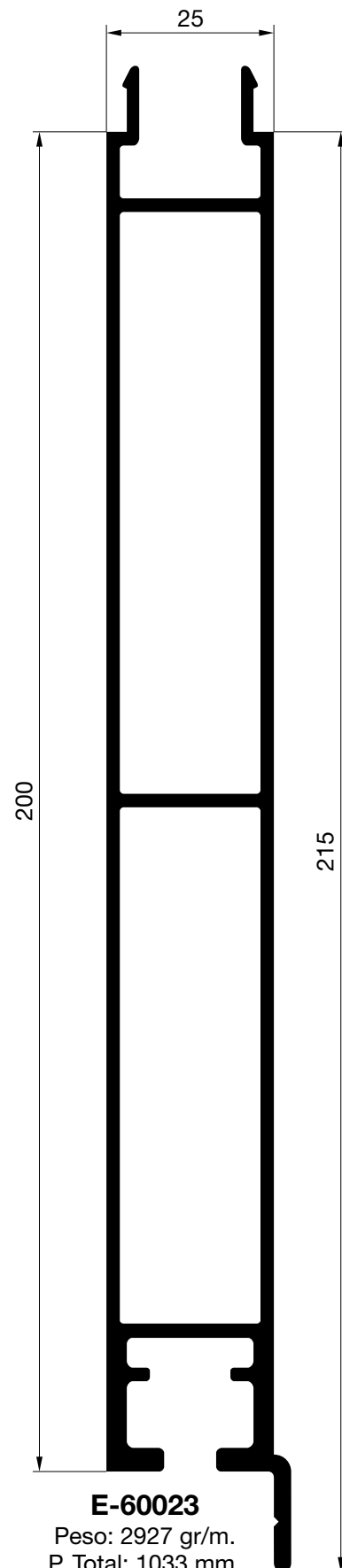

**E-60023**

Peso: 2927 gr/m.  
P. Total: 1033 mm.

PERFILES  
SISTEMAS LATERALES ABATIBLES



HYDRO

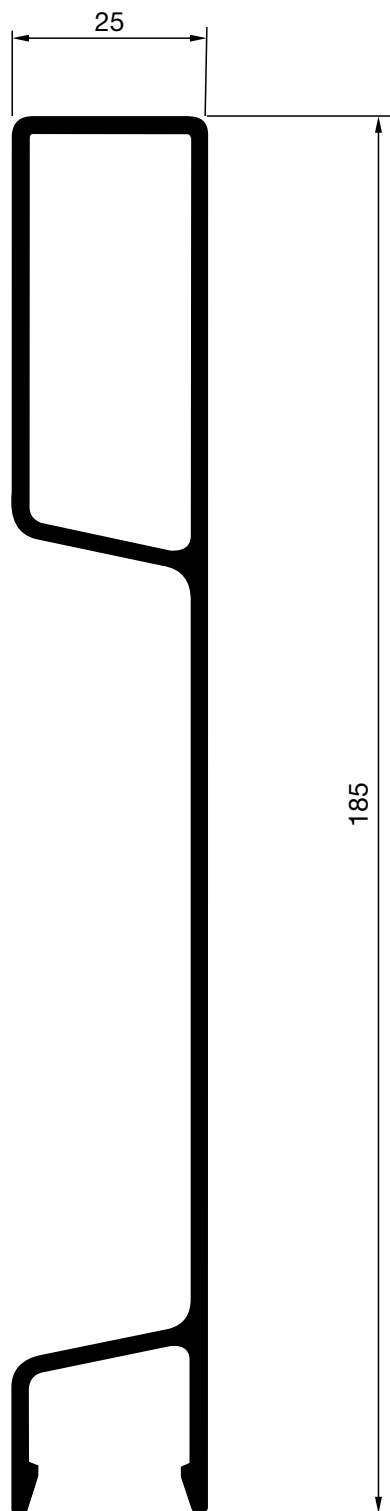

**E-60096**

Peso: 1604 gr/m.

P. Total: 643 mm.

PERFILES  
SISTEMAS LATERALES ABATIBLES



HYDRO

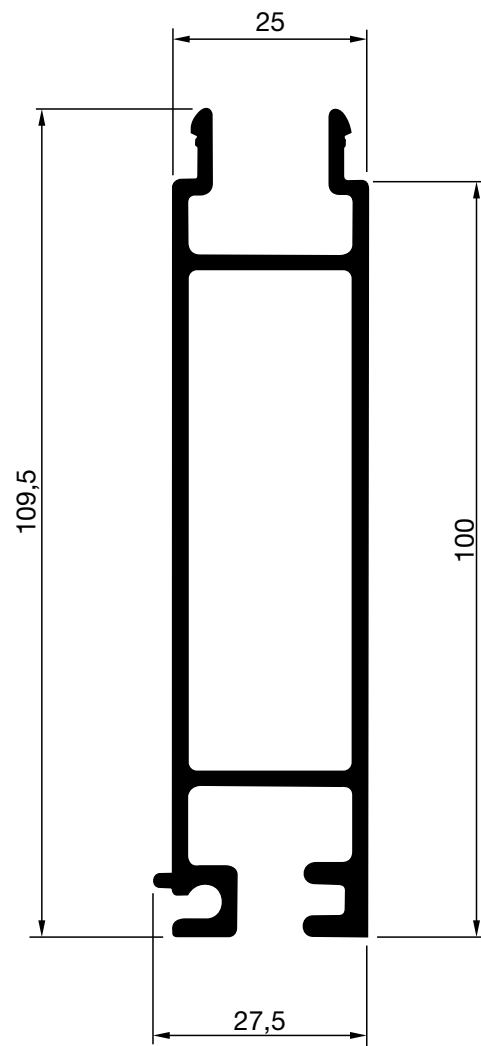

**E-60095**

Peso: 1366 gr/m.

P. Total: 581 mm.

# PERFILES

## SISTEMAS LATERALES ABATIBLES



HYDRO

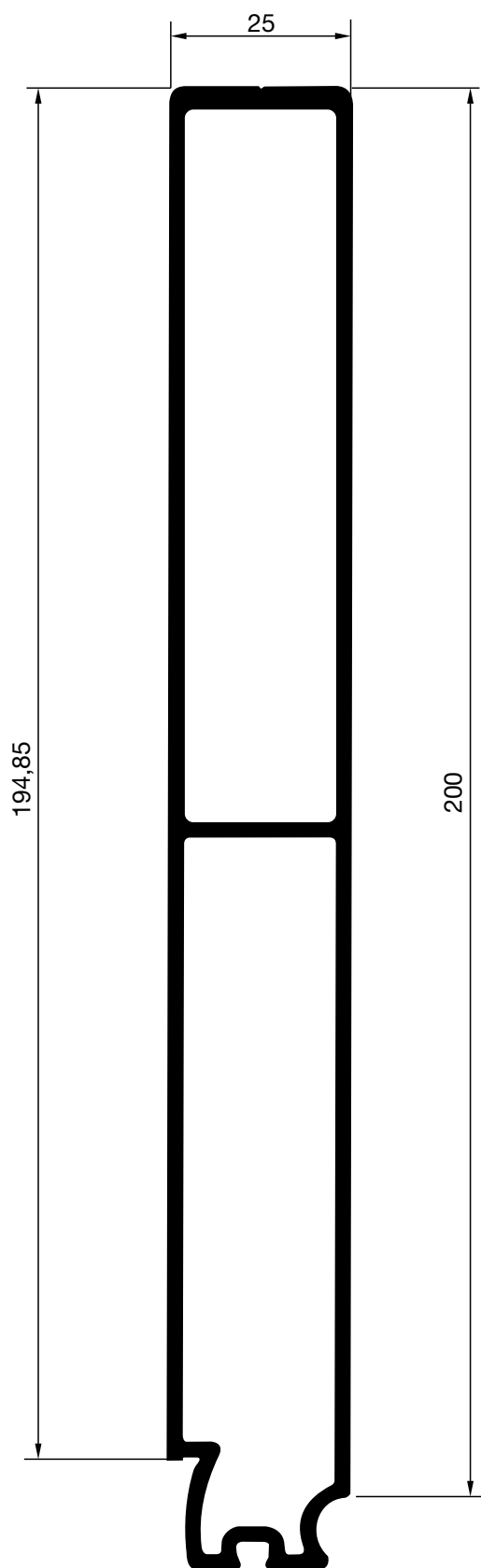

**E-60102**  
Peso: 2360 gr/m.  
P. Total: 974 mm.

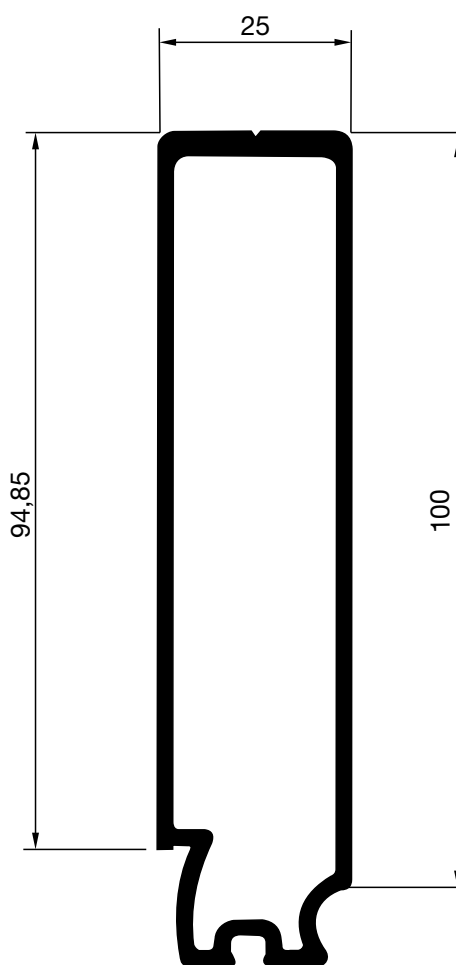

**E-60104**  
Peso: 1339 gr/m.  
P. Total: 536 mm.

PERFILES  
SISTEMAS LATERALES ABATIBLES



HYDRO

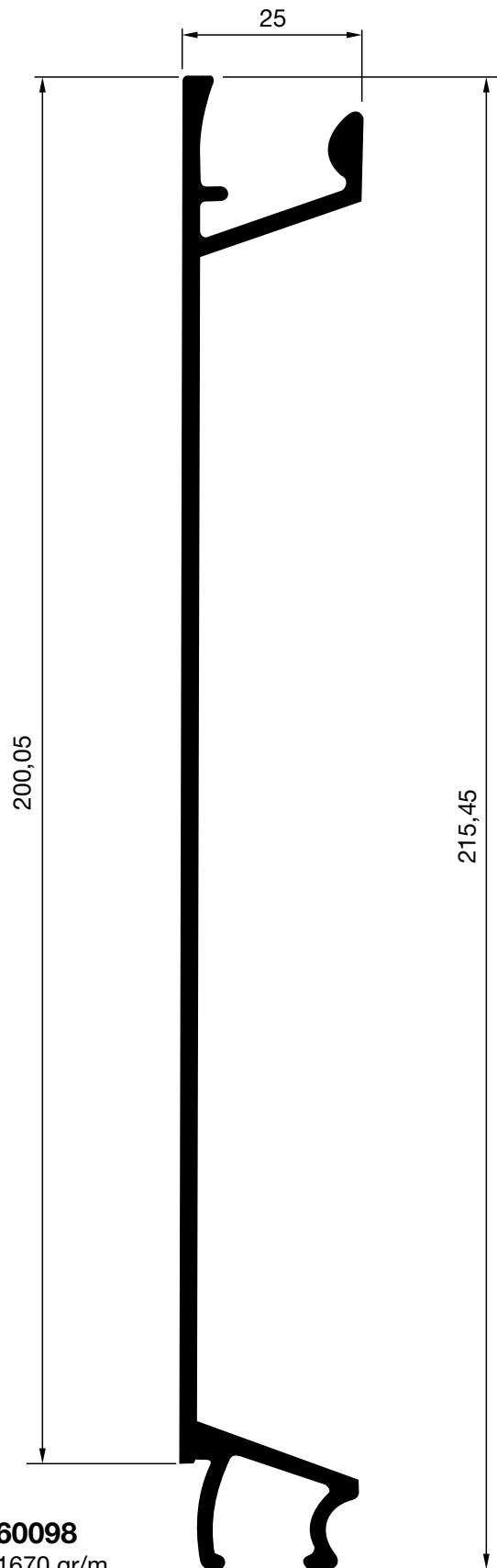

**E-60098**

Peso: 1670 gr/m.  
P. Total: 589 mm.

PERFILES  
SISTEMAS LATERALES ABATIBLES



HYDRO

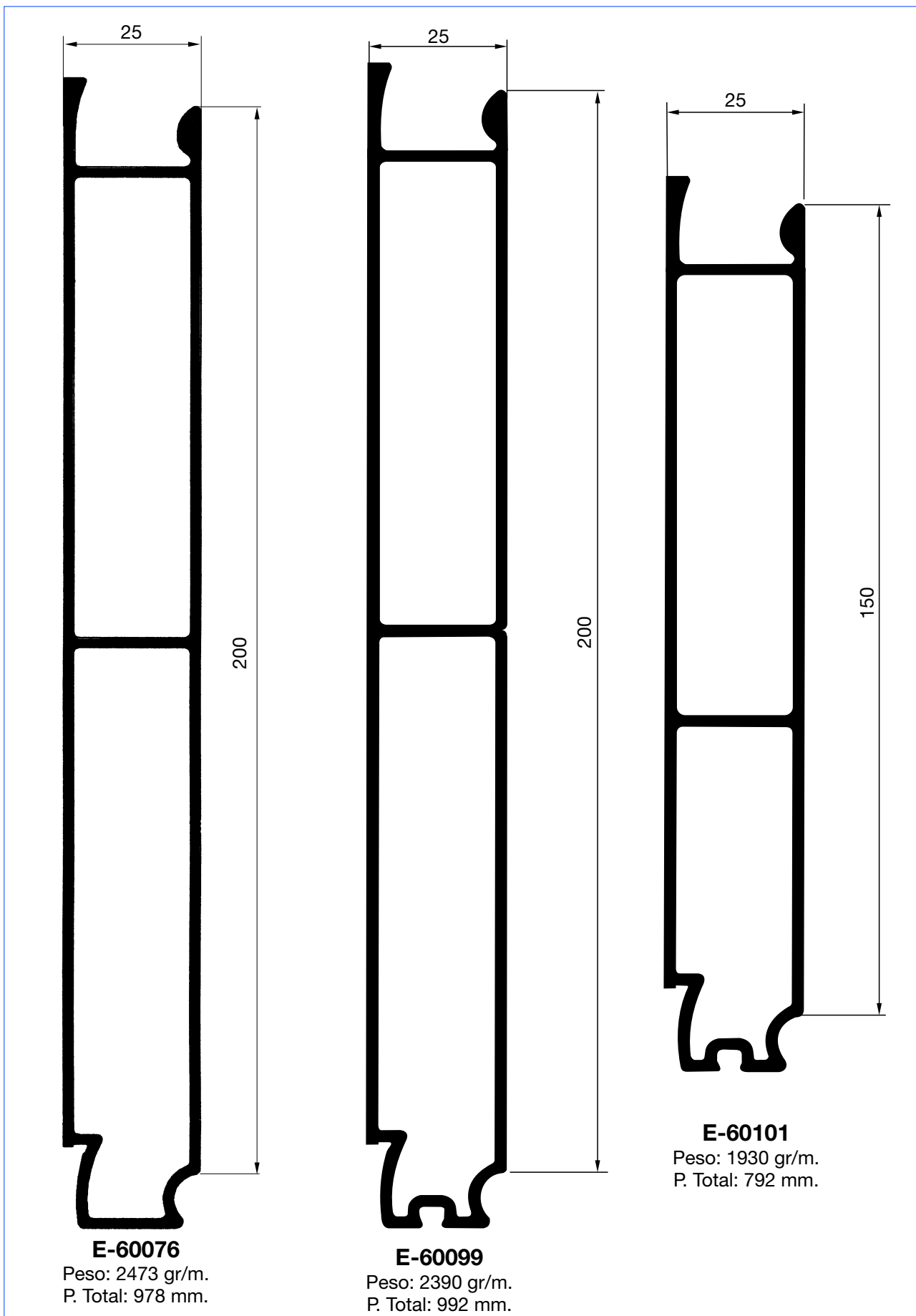

PERFILES  
SISTEMAS LATERALES ABATIBLES



HYDRO

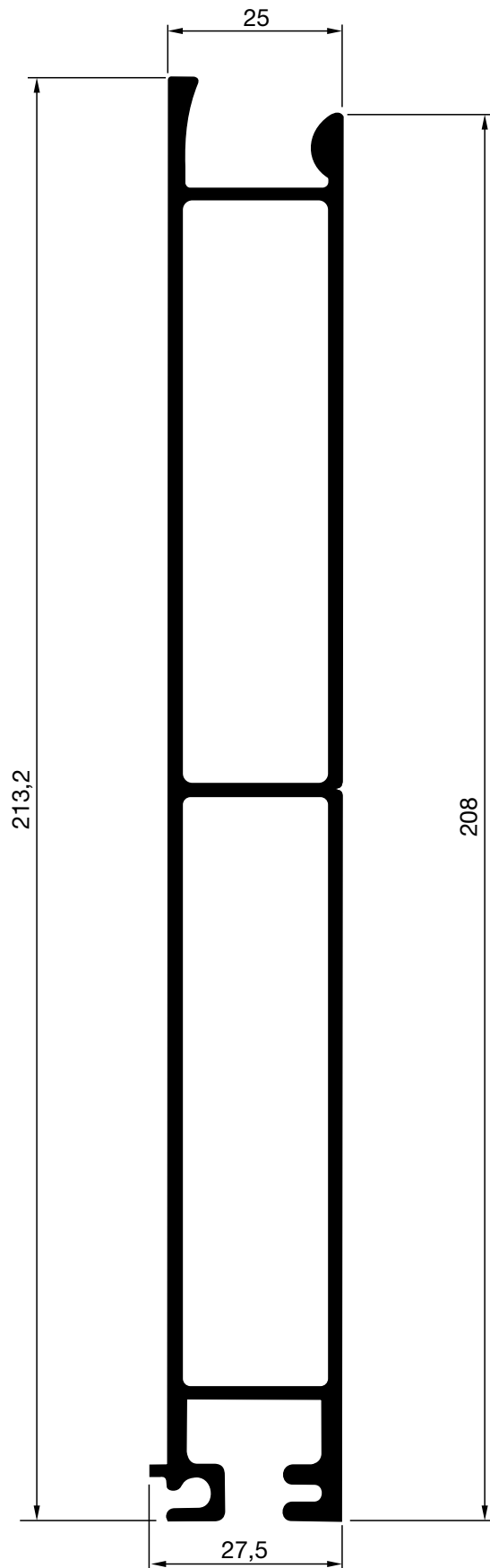

**E-60100**  
Peso: 2537 gr/m.  
P. Total: 1013 mm.

# PERFILES

## SISTEMAS LATERALES ABATIBLES



HYDRO

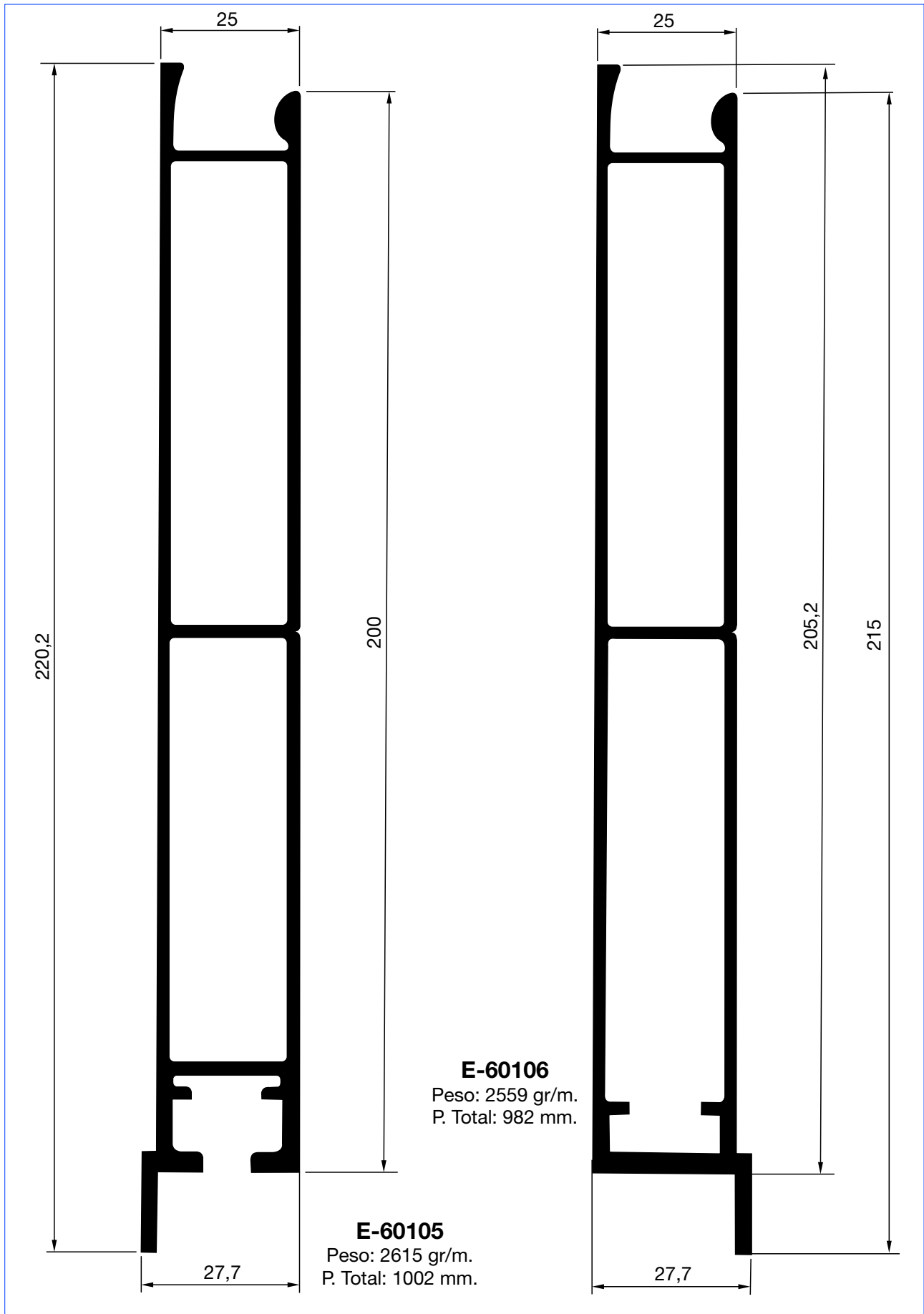

# PERFILES

## SISTEMAS LATERALES ABATIBLES



HYDRO

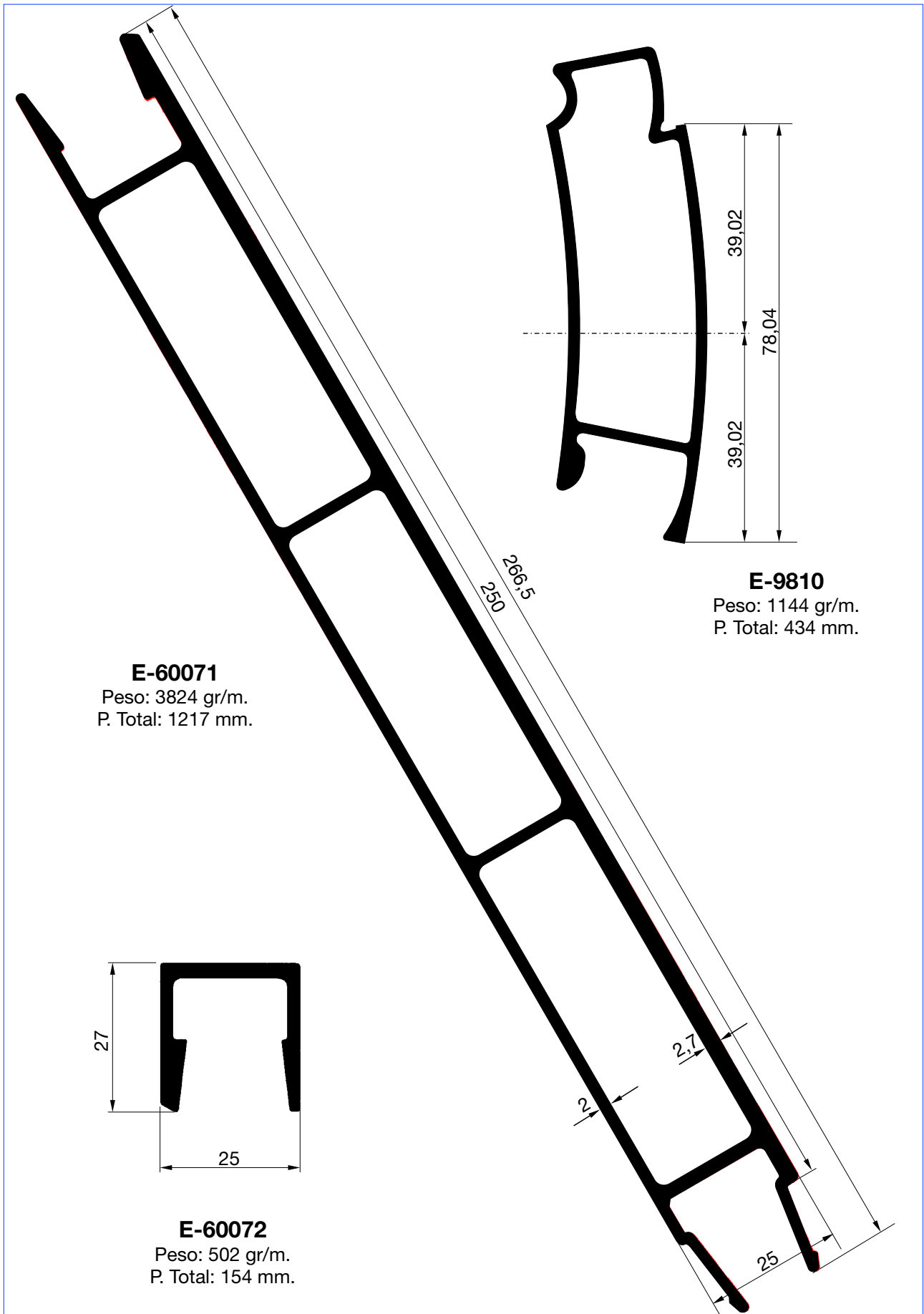

# PERFILES

## SISTEMAS LATERALES ABATIBLES



HYDRO

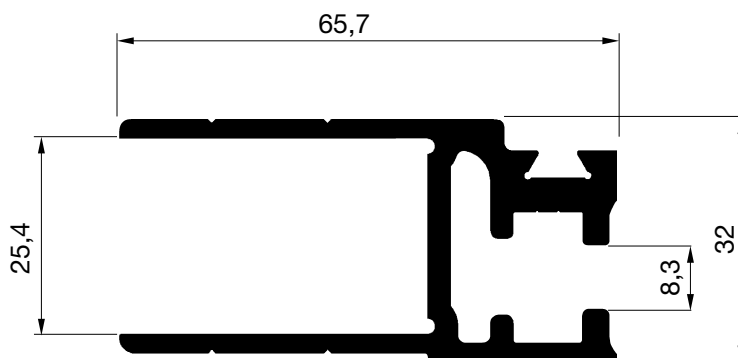

### E-8140

Peso: 1502 gr/m.  
P. Total: 370 mm.

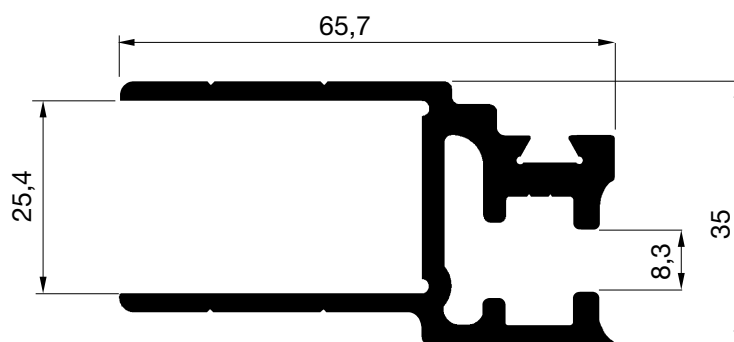

### E-60025

Peso: 1534 gr/m.  
P. Total: 375 mm.

PERFILES TERMINALES PARA LATERALES KINNEGRIP K20

# PERFILES

## SISTEMAS LATERALES ABATIBLES



**HYDRO**

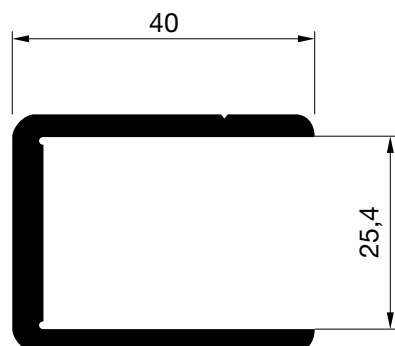

### **E-5470**

Peso: 761 gr/m.  
P. Total: 211 mm.

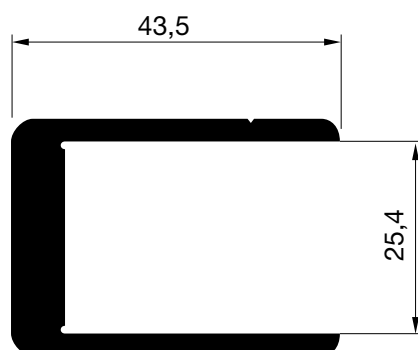

### **E-5843**

Peso: 1048 gr/m.  
P. Total: 218 mm.

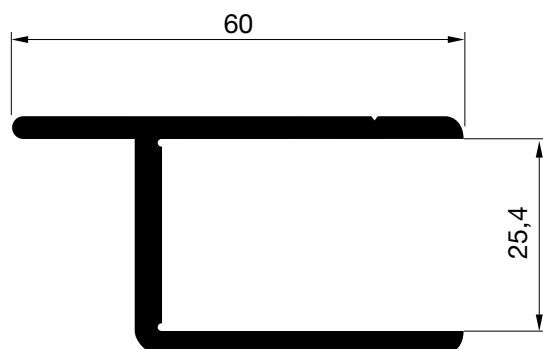

### **E-5651**

Peso: 901 gr/m.  
P. Total: 251 mm.

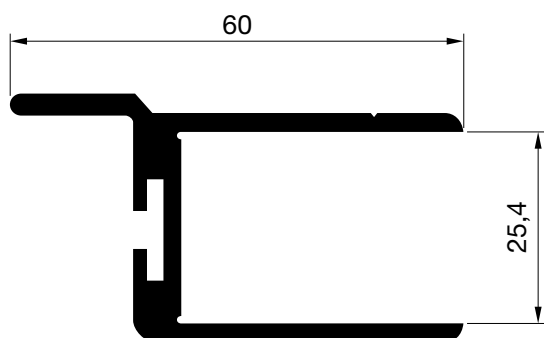

### **E-5471**

Peso: 1042 gr/m.  
P. Total: 275 mm.

# PERFILES

## SISTEMAS LATERALES ABATIBLES



HYDRO

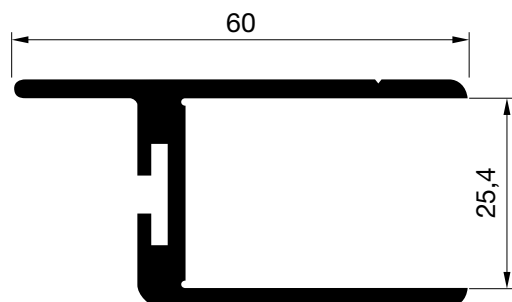

### E-5472

Peso: 1027 gr/m.  
P. Total: 272 mm.

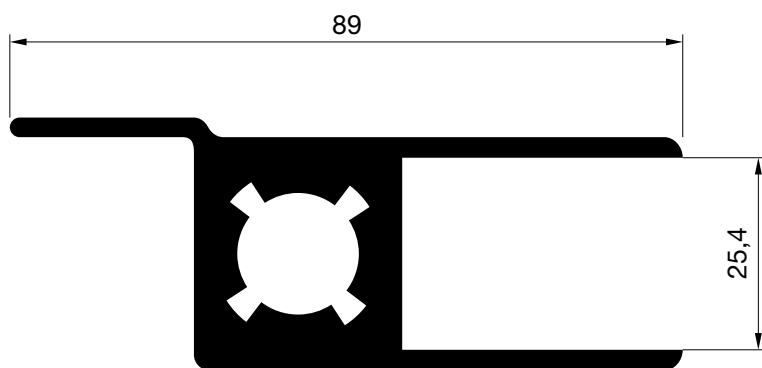

### E-5530

Peso: 2204 gr/m.  
P. Total: 402 mm.

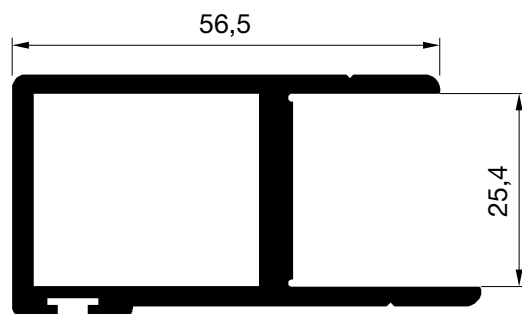

### E-5529

Peso: 1071 gr/m.  
P. Total: 346 mm.

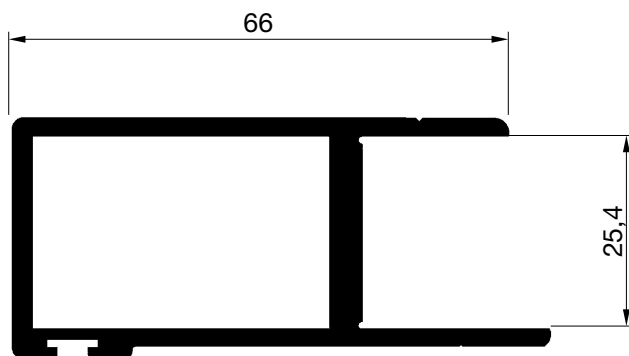

### E-5805

Peso: 1174 gr/m.  
P. Total: 385 mm.

# PERFILES

## SISTEMAS LATERALES ABATIBLES



**HYDRO**

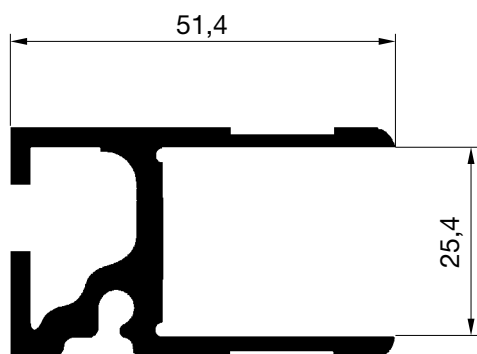

### **E-7547**

Peso: 1107 gr/m.  
P. Total: 304 mm.

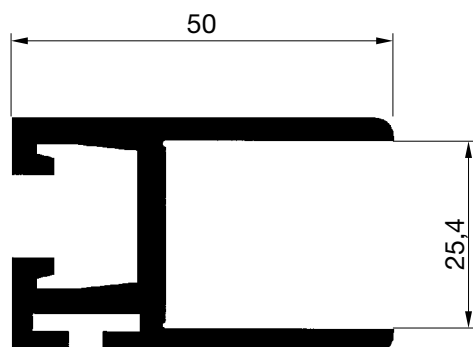

### **E-5468**

Peso: 1097 gr/m.  
P. Total: 311 mm.

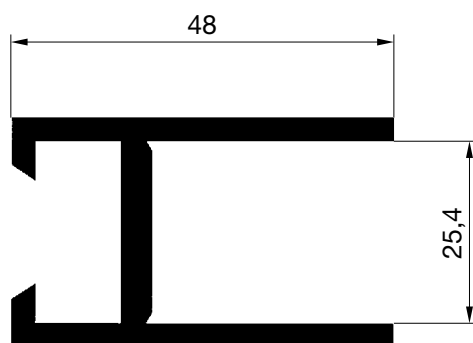

### **E-6543**

Peso: 875 gr/m.  
P. Total: 265 mm.

# PERFILES

## SISTEMAS LATERALES ABATIBLES



HYDRO

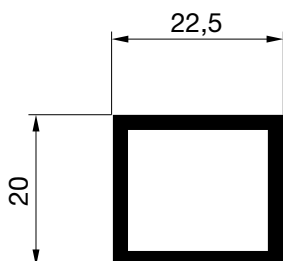

### **E-5653**

Peso: 416 gr/m.  
P. Total: 154 mm.

# PERFILES LONAS Y SEMILONAS



**HYDRO**

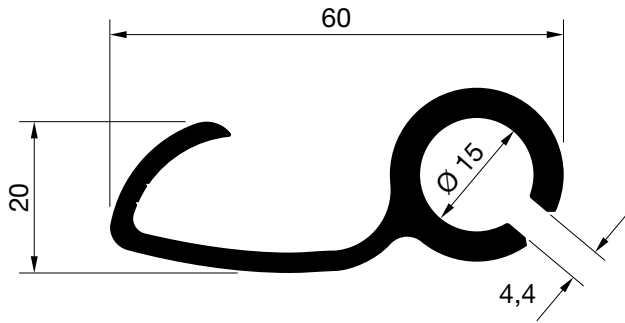

### **E-60042**

Peso: 1050 gr/m.  
P. Total: 237 mm.

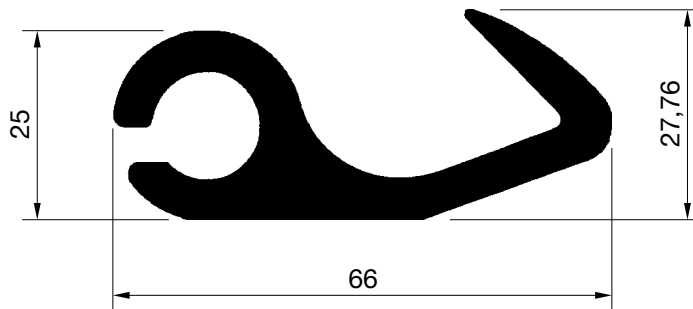

### **E-60003**

Peso: 1763 gr/m.  
P. Total: 246 mm.

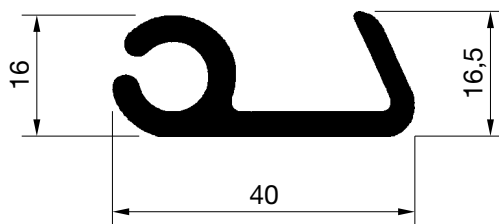

### **E-60004**

Peso: 616 gr/m.  
P. Total: 156 mm.

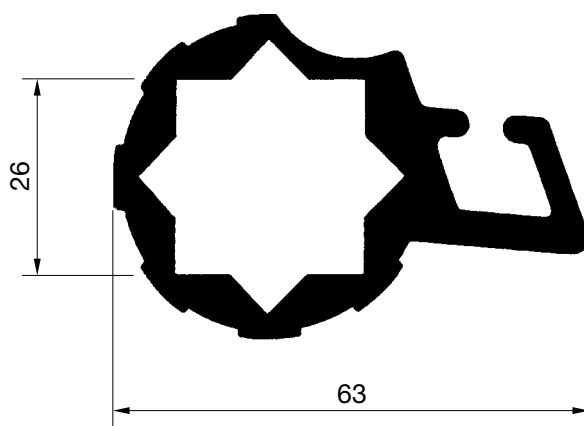

### **E-60005**

Peso: 1914 gr/m.  
P. Total: 343 mm.

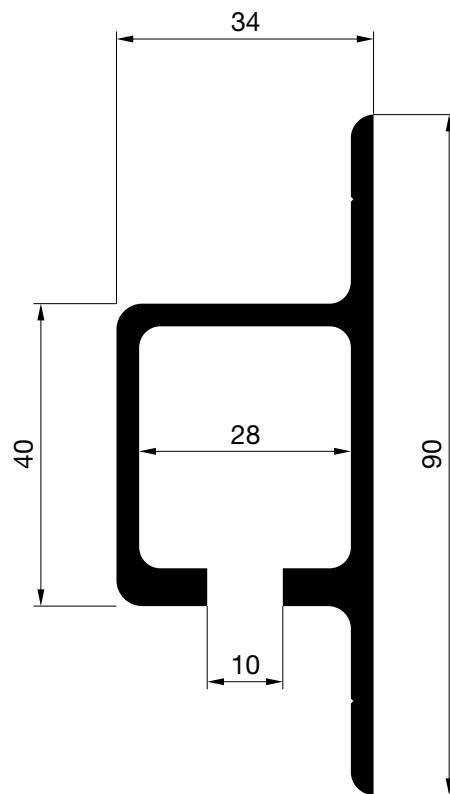

**E-60048**

Peso: 1521 gr/m.

P. Total: 342 mm.

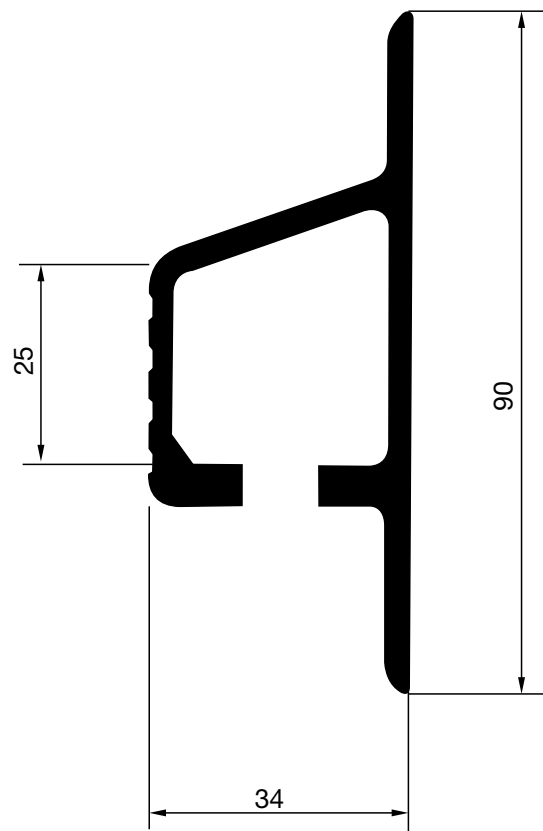

**E-60107**

Peso: 1533 gr/m.

P. Total: 337 mm.

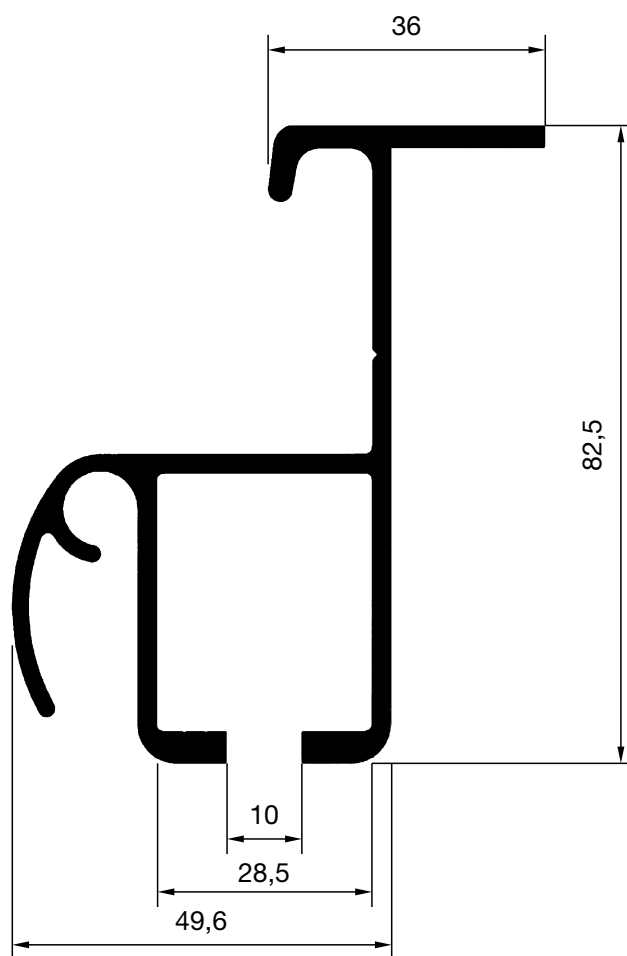

**E-60056**

Peso: 1719 gr/m.

P. Total: 511 mm.

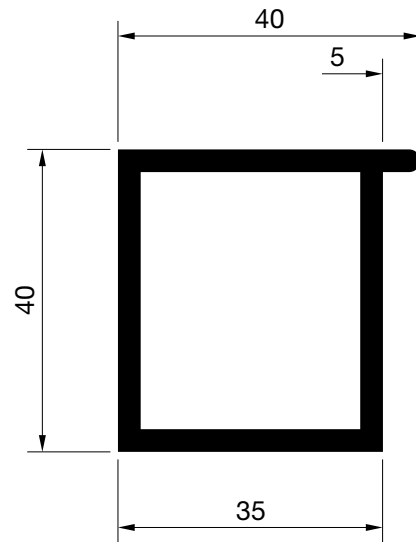

**E-60002**

Peso: 1156 gr/m.

P. Total: 285 mm.

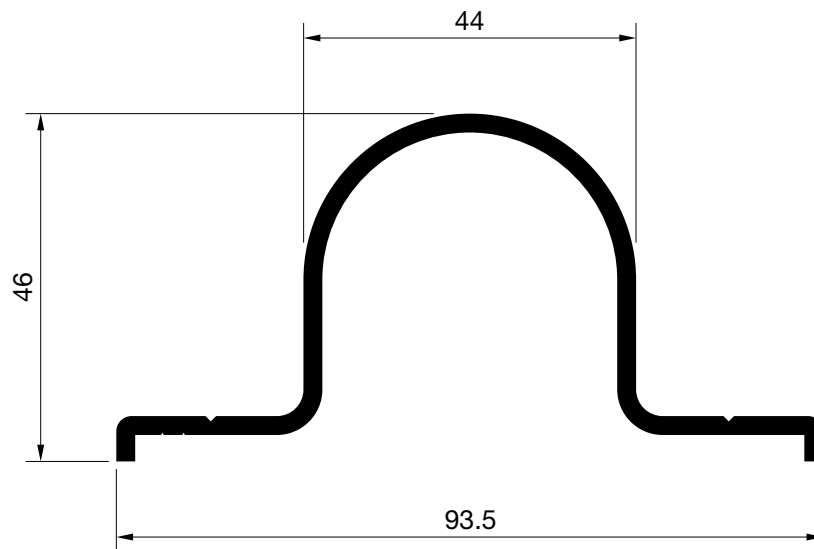

**E-60047**

Peso: 1063 gr/m.

P. Total: 322 mm.

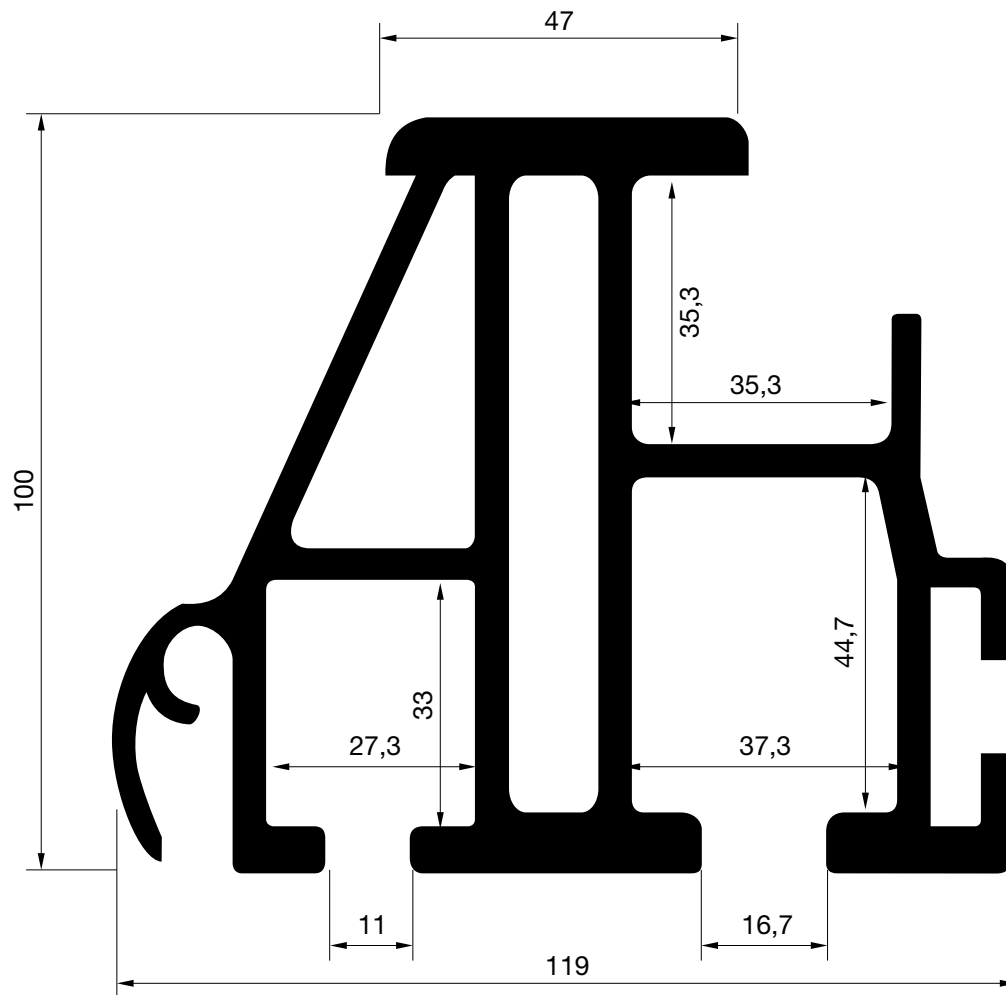

**XMI-3910**

Peso: 7431 gr/m.

P.Total: 842 mm.

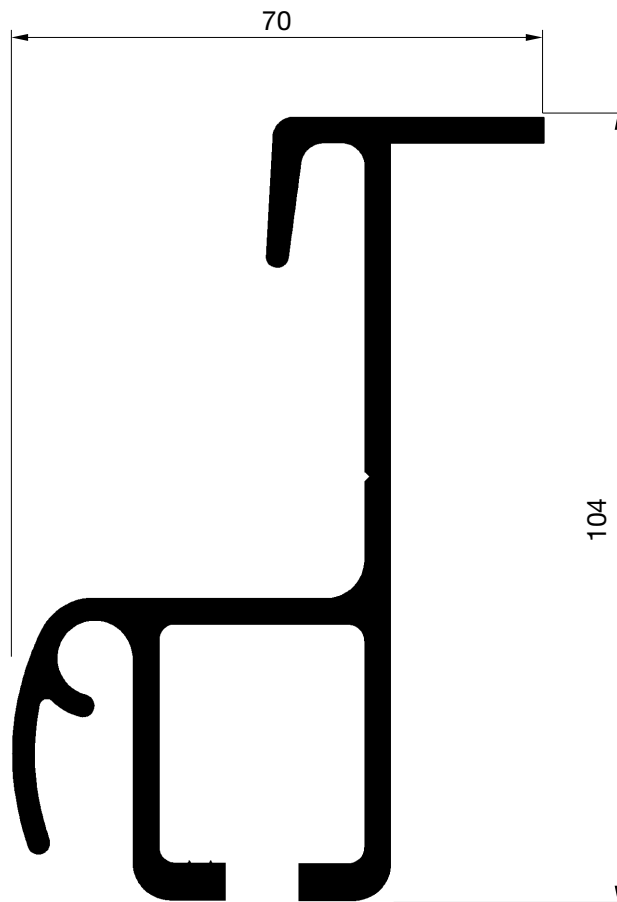

**E-60007**  
Peso: 2489 gr/m.  
P. Total: 559 mm.

PERFILES  
LONAS Y SEMILONAS



HYDRO

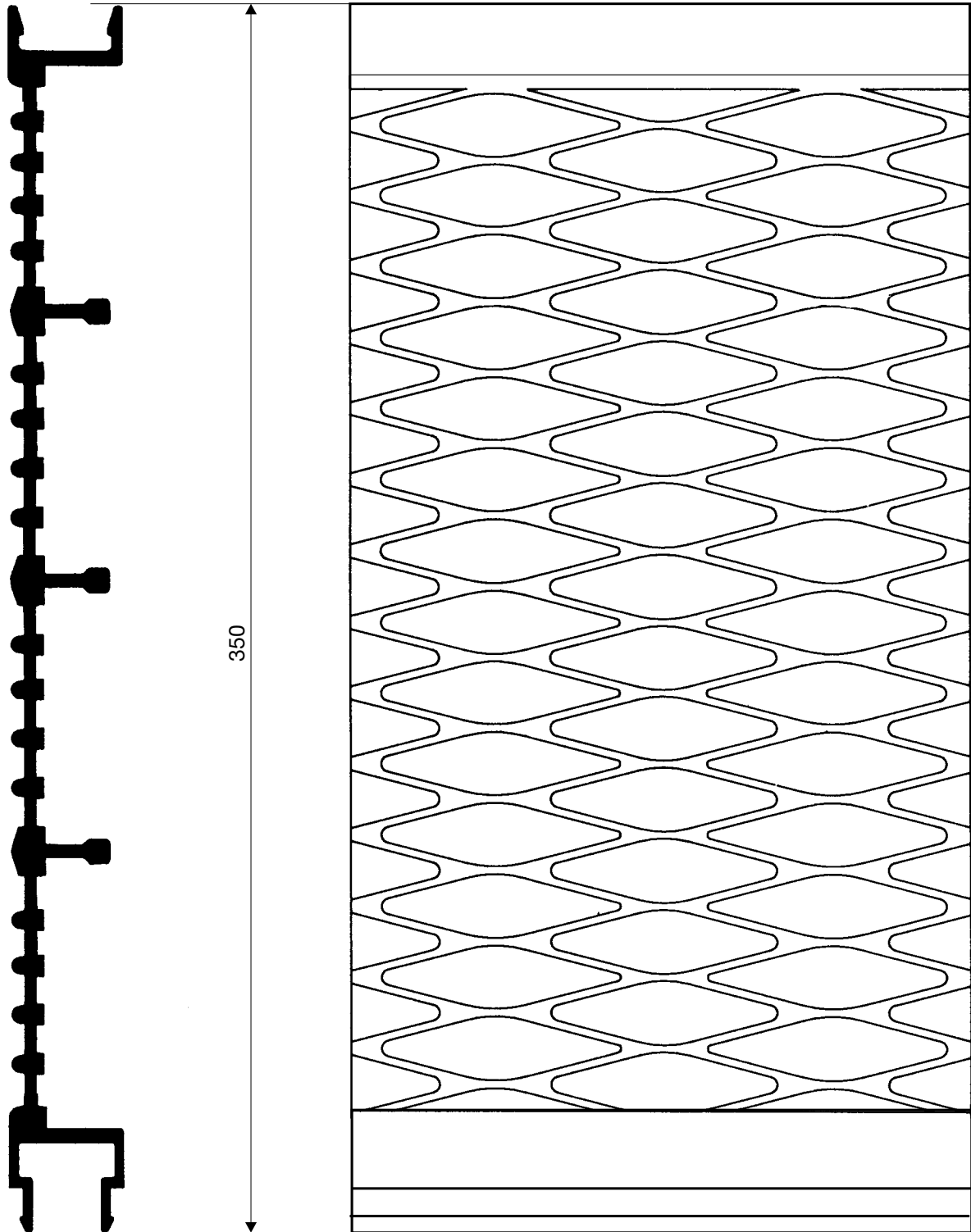

**E-60065**