



Série de TRANSPORTES

# Série de TRANSPORTES

---



A Hydro Alumínio Portalex dedica-se à extrusão de perfis de alumínio de secções variadas, com maior ou menor complexidade, consoante as necessidades dos clientes.

A extrusão de alumínio permite toda a liberdade de concepção em termos de design, de forma a ir de encontro às diferentes necessidades.

Diferentes ligas e ciclos de tratamento térmico, conferem ao produto final distintas propriedades mecânicas, pelo que uma boa definição inicial de características é essencial.

As principais propriedades do alumínio: leveza, condutibilidade, resistência à corrosão e reciclagem, tornam-no num material de construção versátil, altamente utilizável e atractivo, oferecendo largas possibilidades de aplicação em sectores tão distintos como a indústria e a caixilharia.

A Hydro Alumínio Portalex, S.A. oferece aos seus clientes esta Série de TRANSPORTES, composta por perfis e soluções variadas, de modo a abranger um vasto leque de aplicações.

Recorrendo aos seus próprios meios de engenharia ou recorrendo ao suporte científico e técnico do grupo Hydro, a nossa empresa pode apresentar soluções adequadas a projectos específicos.

O presente catálogo apresenta uma nova imagem e organização, incluindo novos perfis e soluções que permite uma consulta mais acessível e funcional.













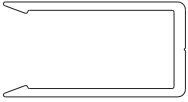
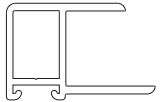

## Índice

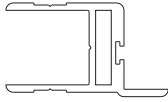
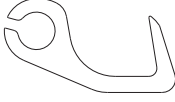



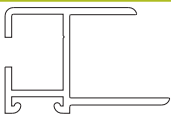
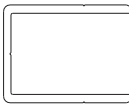
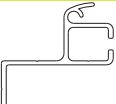
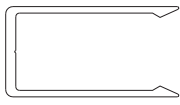

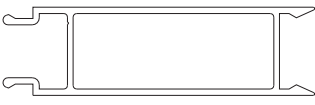

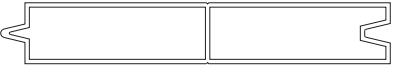
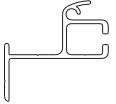
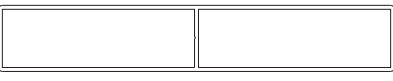
- Índice visual 03
- Perfis 08

# Série de TRANSPORTES



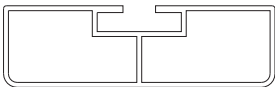
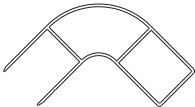

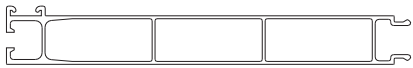

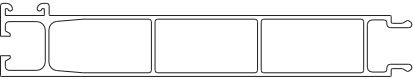
Desenho Referência	Espessura [mm]	Peso [Kg/m]	Área Trat. [m <sup>2</sup> /m]	M. Inércia [cm <sup>4</sup> ]	Pág.
 <b>P21304</b>	1,6	2,121	0,469	I <sub>x</sub> = 136 I <sub>y</sub> = 3208	09
 <b>P21305</b>	1,6	2,404	0,510	I <sub>x</sub> = 162 I <sub>y</sub> = 4265	09
 <b>P21306</b>	2,5	1,679	0,505	I <sub>x</sub> = 4,0 I <sub>y</sub> = 195,4	09
 <b>P21307</b>	2,2	0,726	0,232	I <sub>x</sub> = 2,9 I <sub>y</sub> = 6,2	18
 <b>P21308</b>	2,5	0,959	0,222	I <sub>x</sub> = 5,1 I <sub>y</sub> = 6,4	18
 <b>P21742</b>	2,0	1,247	0,422	I <sub>x</sub> = 0,1 I <sub>y</sub> = 155,6	12
 <b>P21743</b>	2,0	1,500	0,495	I <sub>x</sub> = 3,9 I <sub>y</sub> = 233,2	12
 <b>P21827</b>	2,5	0,991	0,240	I <sub>x</sub> = 6,4 I <sub>y</sub> = 5,7	18
 <b>P21870</b>	6,0	2,006	0,250	I <sub>x</sub> = 7,1 I <sub>y</sub> = 26,4	16
 <b>P22119</b>	2,0	1,208	0,307	I <sub>x</sub> = 5,0 I <sub>y</sub> = 32,1	18



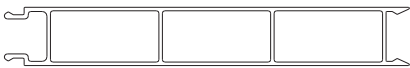

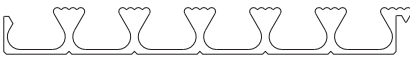
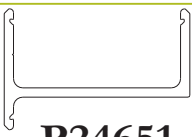
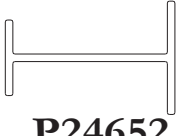
Desenho Referência	Espessura [mm]	Peso [Kg/m]	Área Trat. [m <sup>2</sup> /m]	M. Inércia [cm <sup>4</sup> ]	Pág.
 <b>P22147</b>	2,0	0,784	0,285	I <sub>x</sub> = 4,2 I <sub>y</sub> = 4,9	18
 <b>P22236</b>	2,6	0,708	0,213	I <sub>x</sub> = 4,3 I <sub>y</sub> = 4,2	18
 <b>P22266</b>	3,3	2,385	0,499	I <sub>x</sub> = 39,4 I <sub>y</sub> = 76,0	17
 <b>P22385</b>	1,8	0,632	0,266	I <sub>x</sub> = 2,6 I <sub>y</sub> = 5,6	19
 <b>P22386</b>	1,8	0,703	0,301	I <sub>x</sub> = 2,6 I <sub>y</sub> = 4,6	19
 <b>P22387</b>	1,8	1,092	0,294	I <sub>x</sub> = 4,5 I <sub>y</sub> = 29,0	19
 <b>P22953</b>	1,8	1,473	0,287	I <sub>x</sub> = 6,2 I <sub>y</sub> = 78,1	11
 <b>P23330</b>	1,8	1,926	0,382	I <sub>x</sub> = 7,8 I <sub>y</sub> = 174,7	13
 <b>P23488</b>	3,3	2,541	0,517	I <sub>x</sub> = 39,8 I <sub>y</sub> = 87,2	17
 <b>P23677</b>	1,5	1,477	0,347	I <sub>x</sub> = 6,6 I <sub>y</sub> = 119,7	11

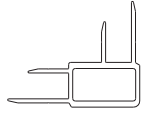
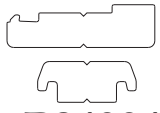
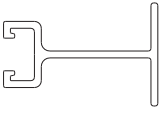
# Série de TRANSPORTES

Desenho Referência	Espessura [mm]	Peso [Kg/m]	Área Trat. [m <sup>2</sup> /m]	M. Inércia [cm <sup>4</sup> ]	Pág.
 <b>P23728</b>	1,5	1,234	0,287	I <sub>x</sub> = 5,4 I <sub>y</sub> = 65,7	11
 <b>P23861</b>	1,4	1,380	0,347	I <sub>x</sub> = 6,2 I <sub>y</sub> = 112,0	11
 <b>P23895</b>	1,6	1,456	0,322	I <sub>x</sub> = 5,7 I <sub>y</sub> = 87,9	13
 <b>P23903</b>	1,8	1,513	0,312	I <sub>x</sub> = 7,9 I <sub>y</sub> = 52,7	16
 <b>P23904</b>	1,8	1,735	0,413	I <sub>x</sub> = 22,0 I <sub>y</sub> = 71,7	16
 <b>P23984</b>	1,4	1,439	0,362	I <sub>x</sub> = 6,6 I <sub>y</sub> = 115,9	13
 <b>P24375</b>	1,5	2,472	0,609	I <sub>x</sub> = 10,9 I <sub>y</sub> = 410,4	10
 <b>P24376</b>	2,2	1,705	0,585	I <sub>x</sub> = 3,8 I <sub>y</sub> = 300,6	10
 <b>P24377</b>	1,5	2,113	0,494	I <sub>x</sub> = 9,5 I <sub>y</sub> = 326,7	10
 <b>P24441</b>	1,5	2,152	0,527	I <sub>x</sub> = 9,2 I <sub>y</sub> = 233,2	08

# Série de TRANSPORTES

Desenho Referência	Espessura [mm]	Peso [Kg/m]	Área Trat. [m <sup>2</sup> /m]	M. Inércia [cm <sup>4</sup> ]	Pág.
 <b>P24442</b>	1,5	1,873	0,462	$I_x = 8,0$ $I_y = 193,7$	08
 <b>P24443</b>	2,0	1,334	0,505	$I_x = 3,5$ $I_y = 155,7$	08
 <b>P24467</b>	2,5	4,736	0,810	$I_x = 13,2$ $I_y = 657,3$	12
 <b>P24651</b>	5,0	2,708	0,410	$I_x = 21,4$ $I_y = 153,2$	15
 <b>P24652</b>	4,0	1,962	0,367	$I_x = 9,3$ $I_y = 90,4$	15
 <b>P24653</b>	4,0	2,794	0,498	$I_x = 37,0$ $I_y = 203,3$	14
 <b>P24654</b>	4,0	4,953	0,610	$I_x = 117,7$ $I_y = 208,6$	14
 <b>P24884</b>	--	1,050	0,104	$I_x = --$ $I_y = --$	20
 <b>P24885</b>	4,0	2,314	0,421	$I_x = 13,9$ $I_y = 94,1$	15
 <b>P25108</b>	2,2	3,512	0,592	$I_x = 12,1$ $I_y = 620,4$	20

Desenho Referência	Espessura [mm]	Peso [Kg/m]	Área Trat. [m <sup>2</sup> /m]	M. Inércia [cm <sup>4</sup> ]	Pág.
 <b>P25176</b>	5,0	2,424	0,367	I <sub>x</sub> = 15,6 I <sub>y</sub> = 131,3	15
 <b>P25388</b>	1,4	1,427	0,361	I <sub>x</sub> = 6,0 I <sub>y</sub> = 114,5	13
 <b>P53629</b>	4,0	3,067	0,300	I <sub>x</sub> = 47,4 I <sub>y</sub> = 144,1	16
 <b>P53711</b>	3,0	1,664	0,215	I <sub>x</sub> = 16,01 I <sub>y</sub> = 39,1	16

NOTA: Os momentos de inércia aqui apresentados são calculados com base no eixo

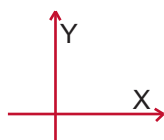

com a posição dos perfis indicada neste índice.

# Série de TRANSPORTES

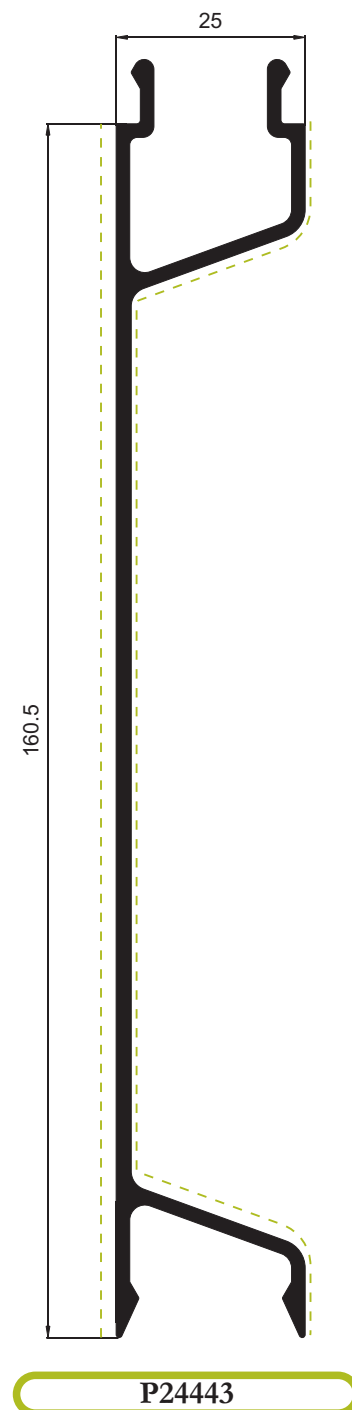
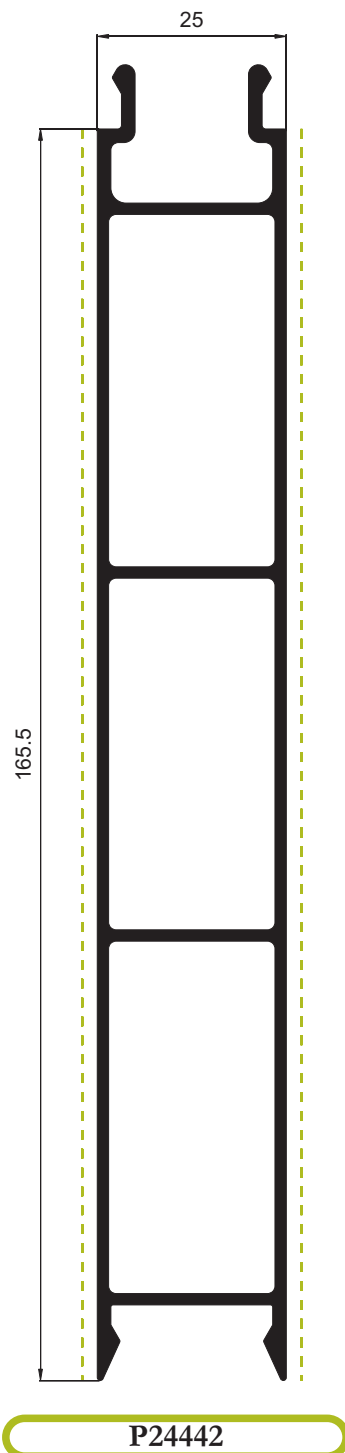
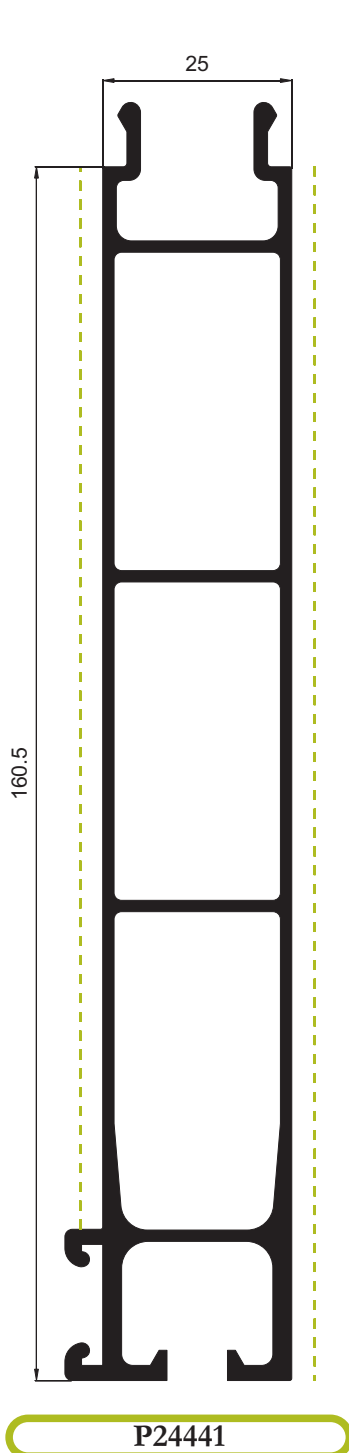

# Série de TRANSPORTES

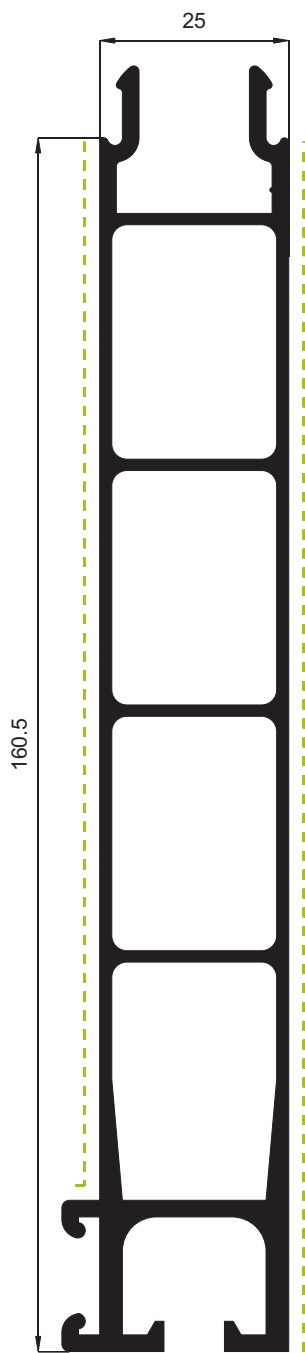

P21305

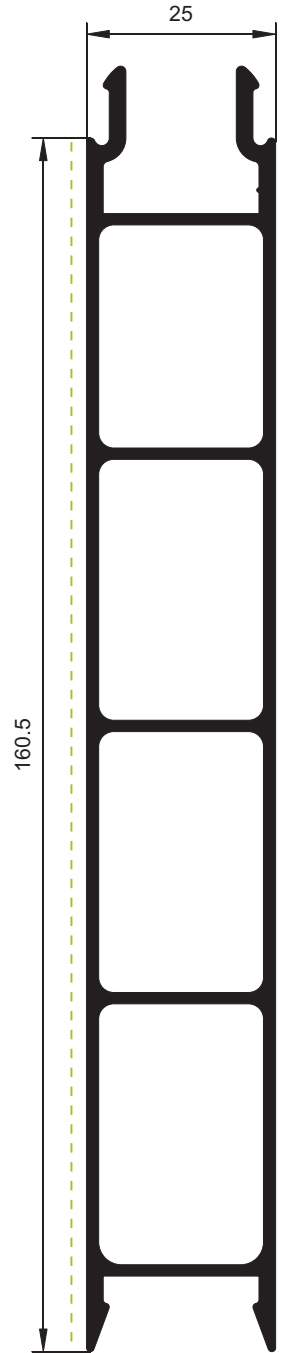

P21304

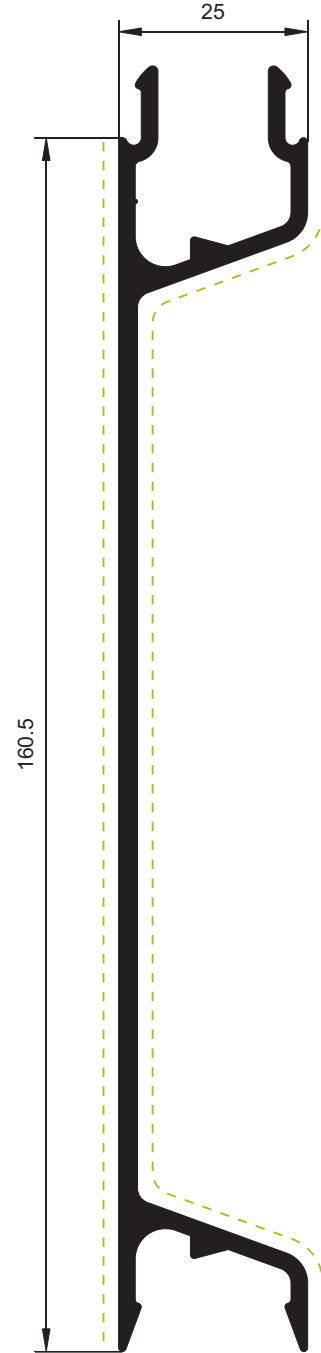

P21306

# Série de TRANSPORTES



HYDRO

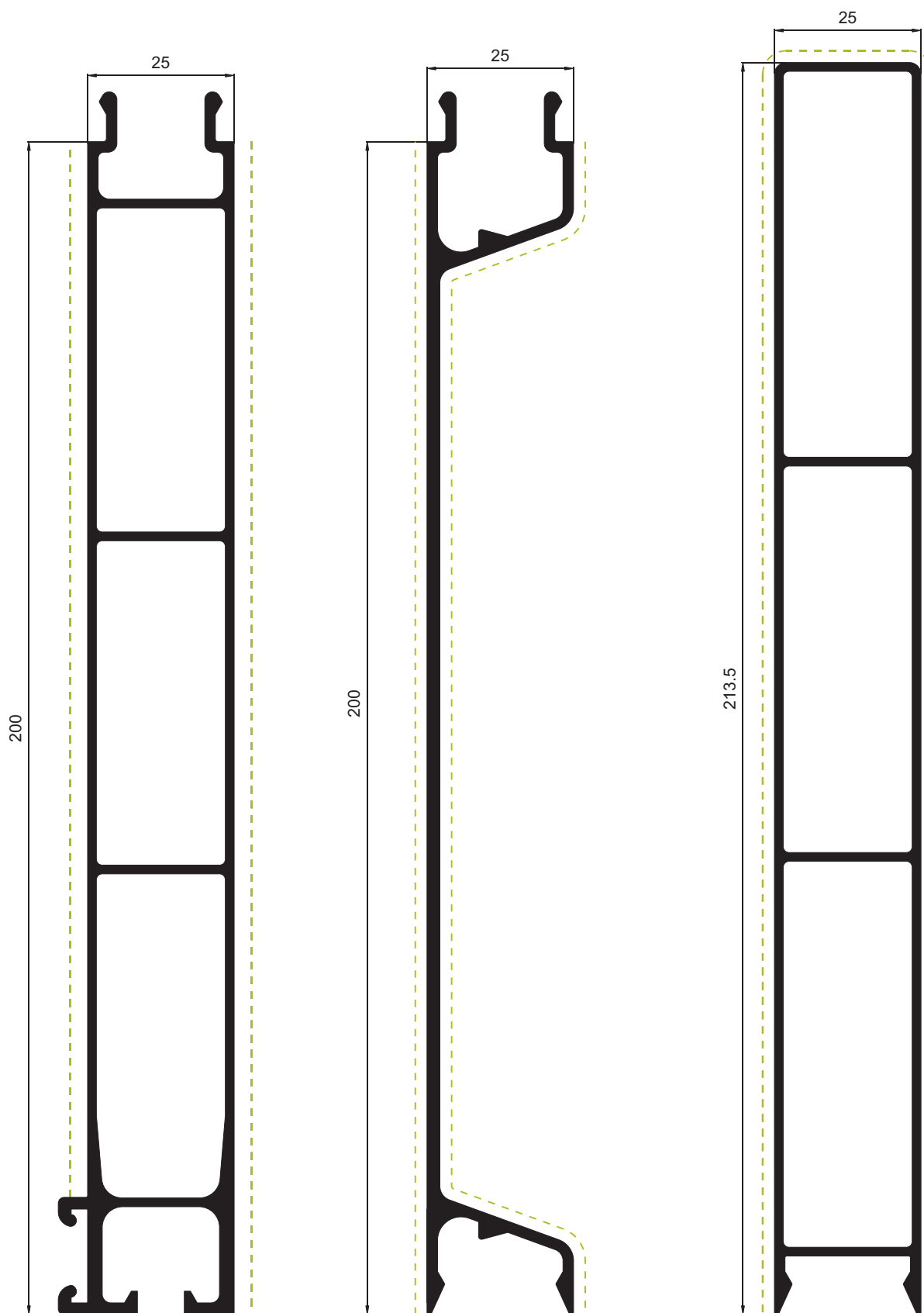

P24375

P24376

P24377

Hydro Alumínio Portalex, S. A.

Perfis

Catálogo  
06\_4.1



10

# Série de TRANSPORTES

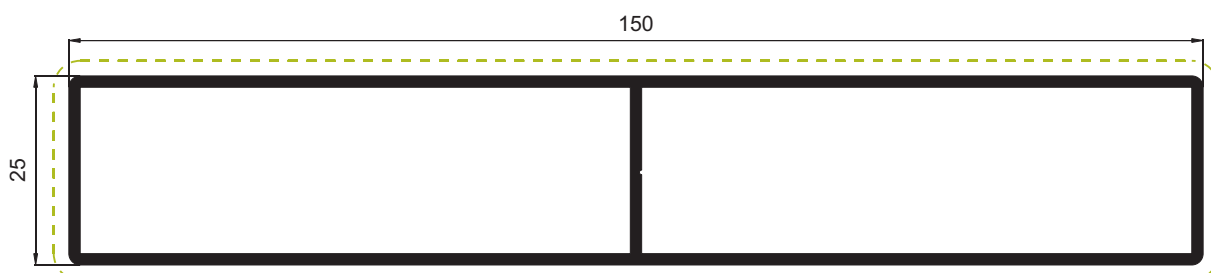

P23677

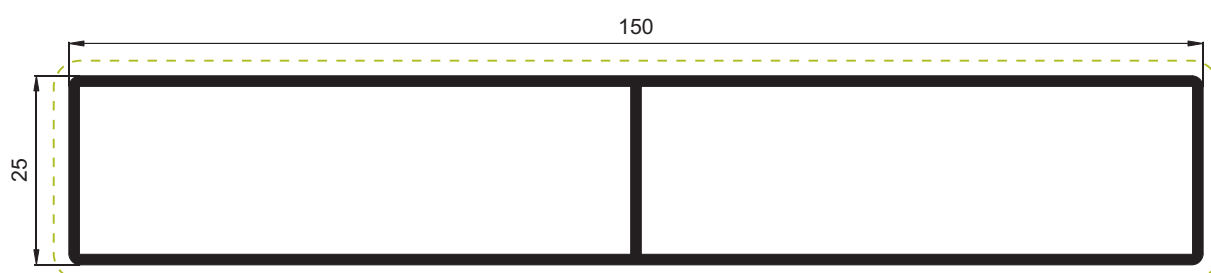

P23861

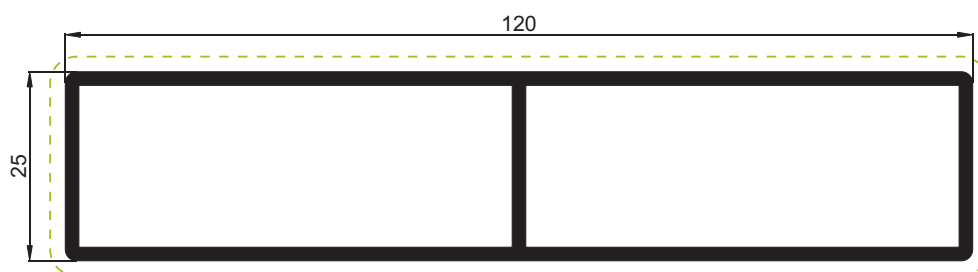

P22953

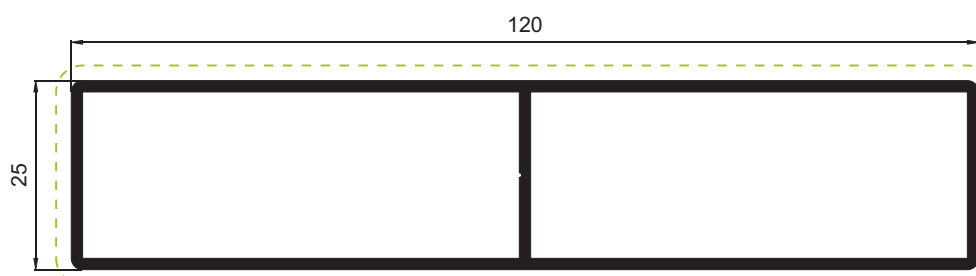

P23728

# Série de TRANSPORTES



HYDRO

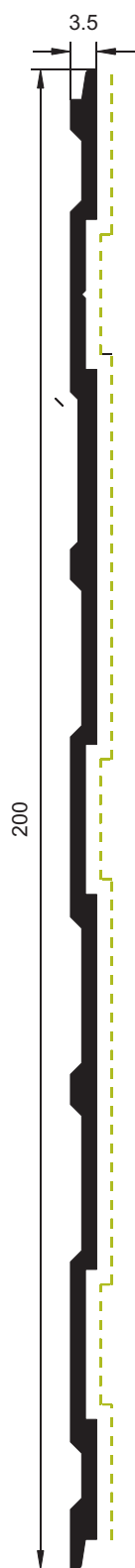

P21742

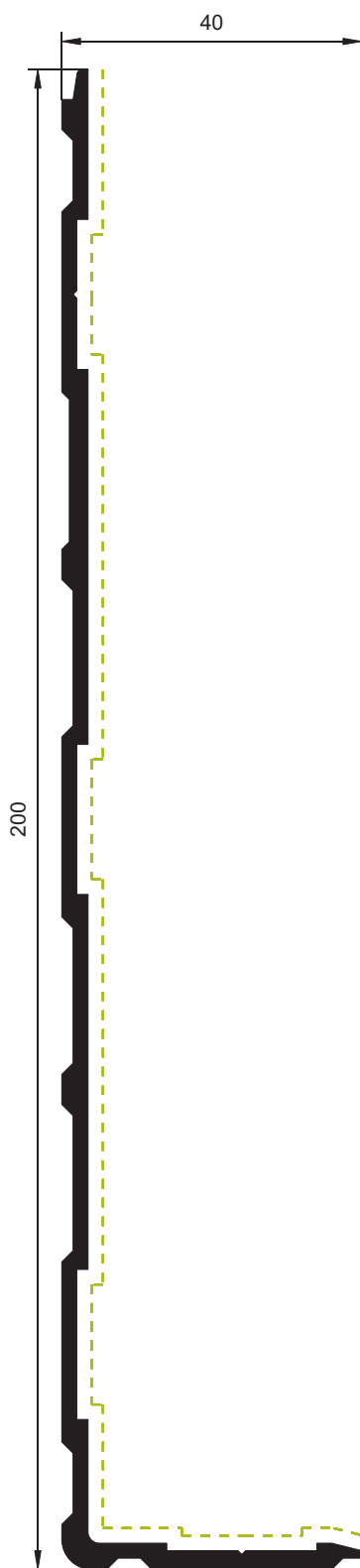

P21743

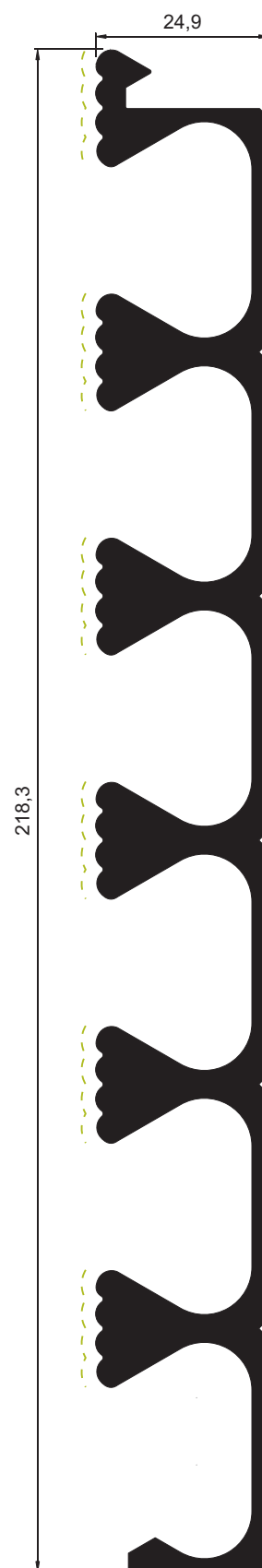

P24467

Hydro Alumínio Portalex, S. A.

Perfis

Catálogo  
06\_4.1

12

# Série de TRANSPORTES

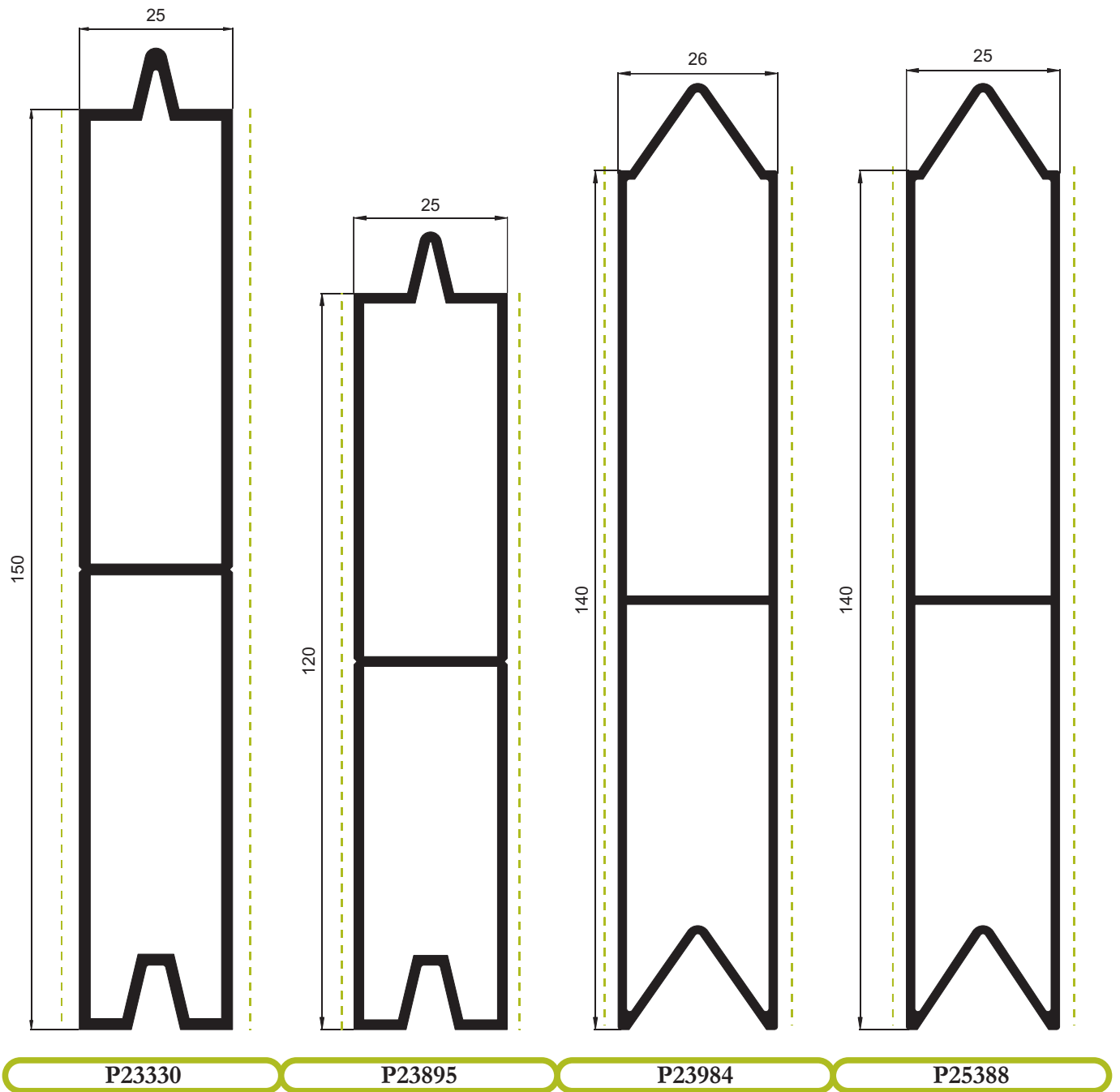

# Série de TRANSPORTES

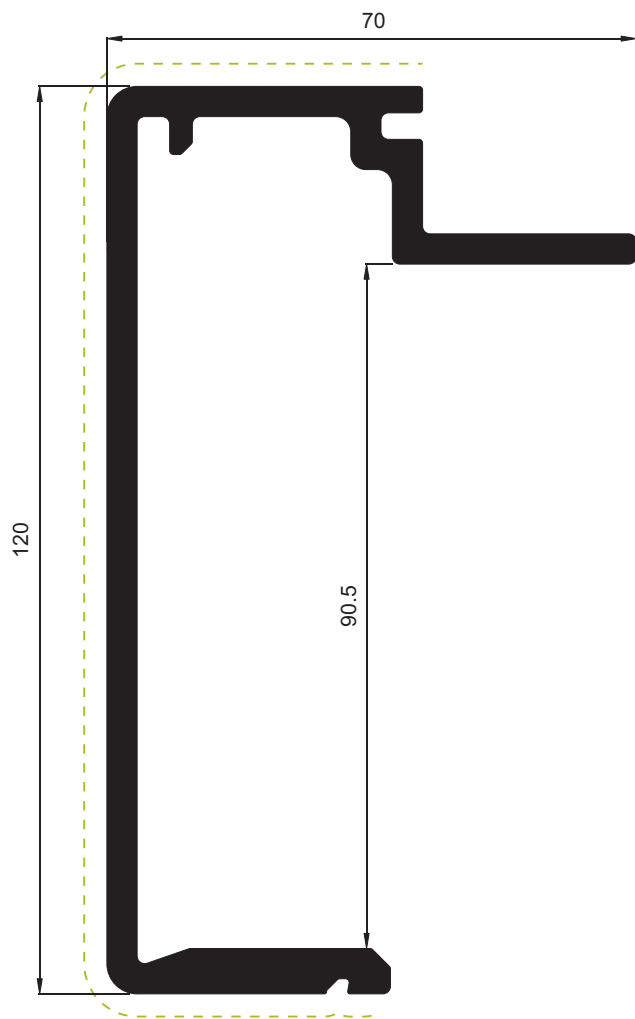

P24653

P24654

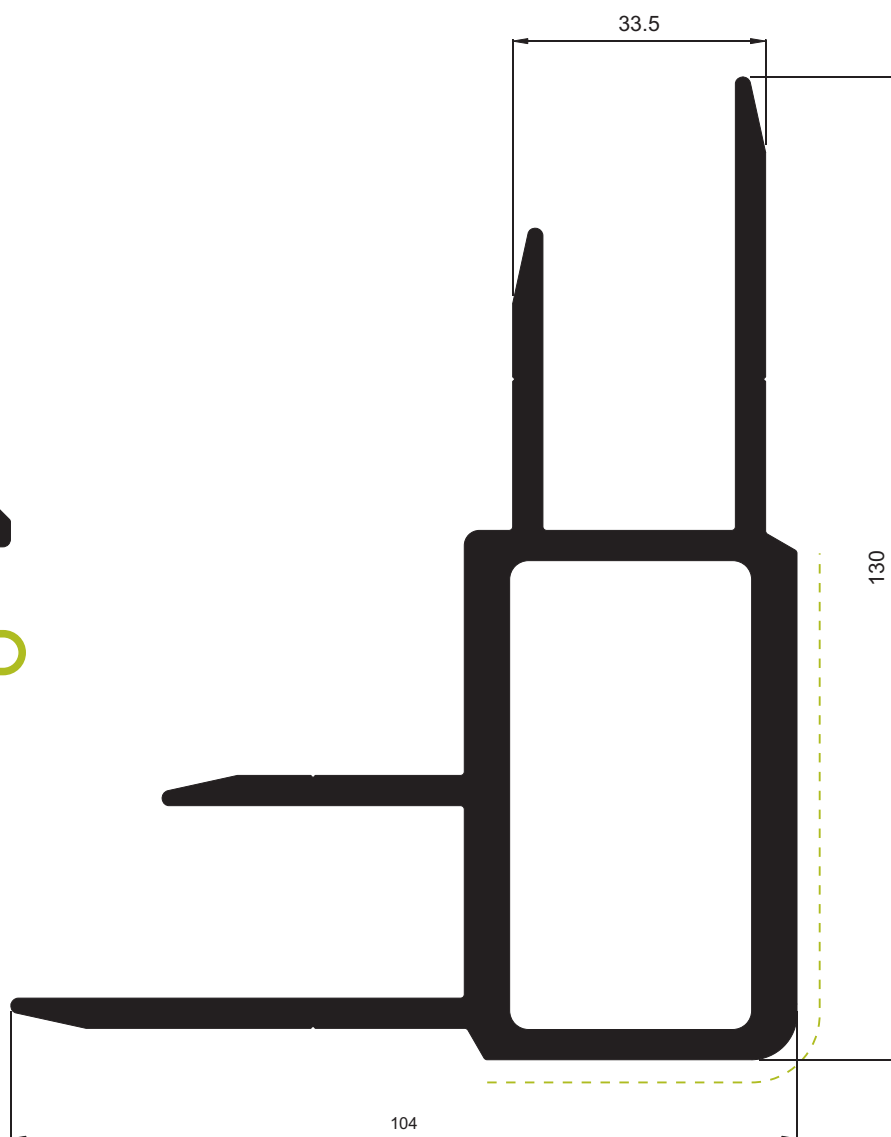

# Série de TRANSPORTES

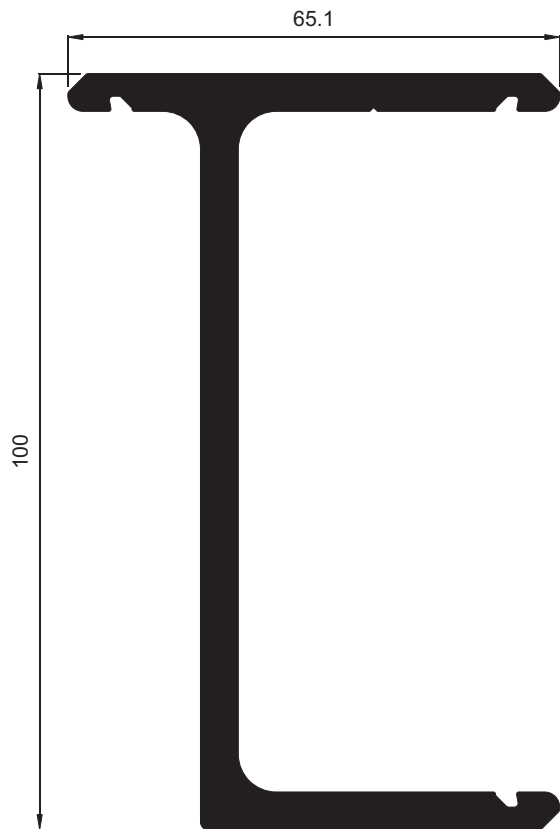

P24651

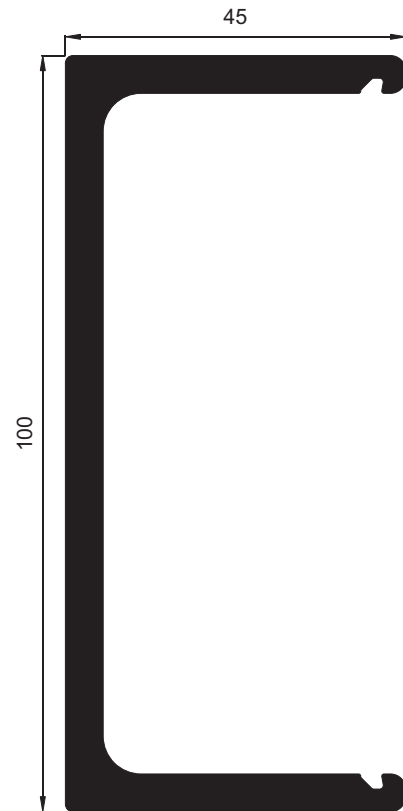

P25176

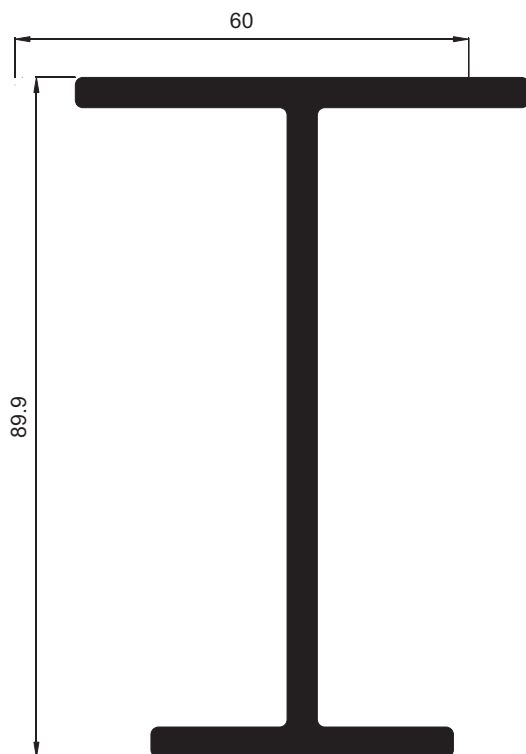

P24652

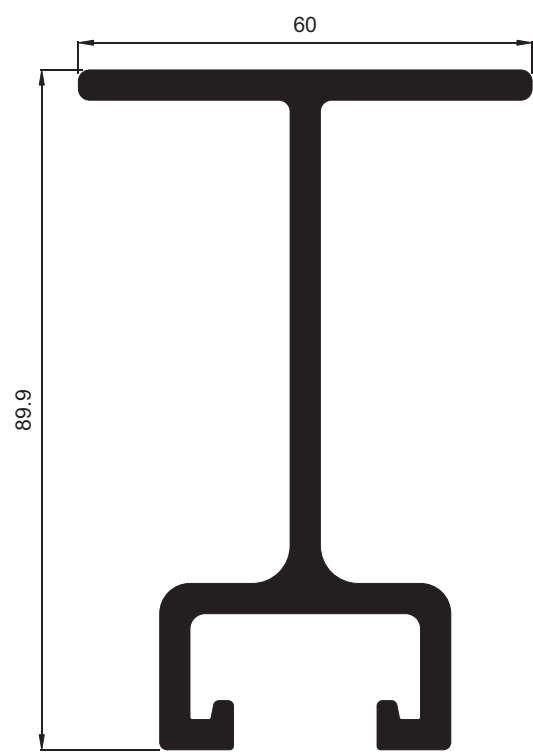

P24885

Hydro Alumínio Portalex, S. A.

Perfis

Catálogo  
06\_4.1

15

# Série de TRANSPORTES

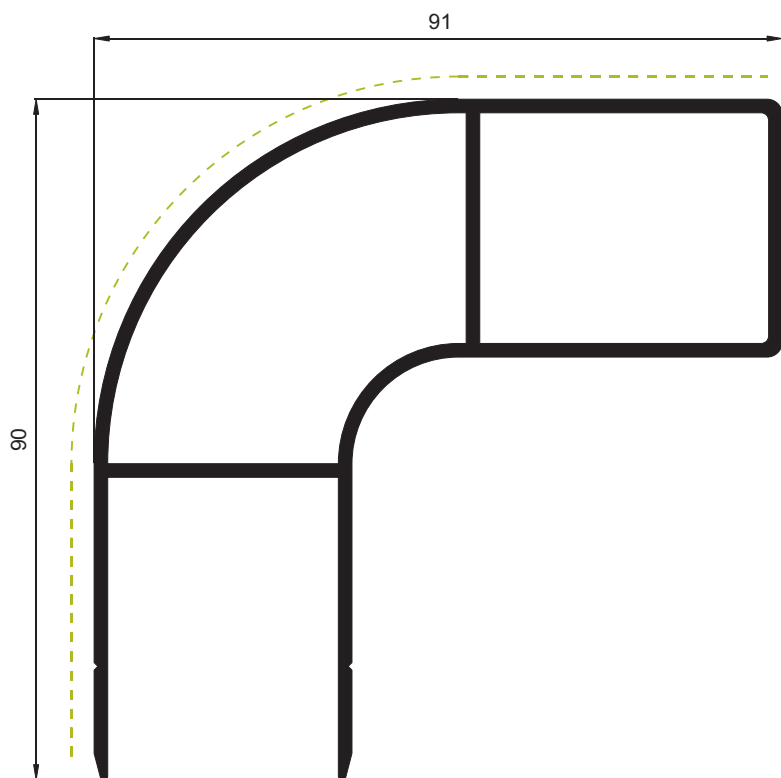

P23904

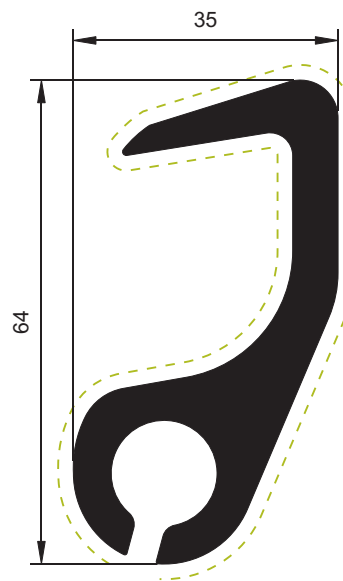

P21870

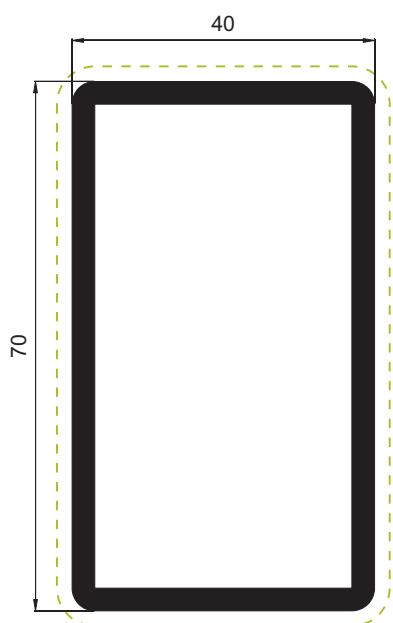

P53711

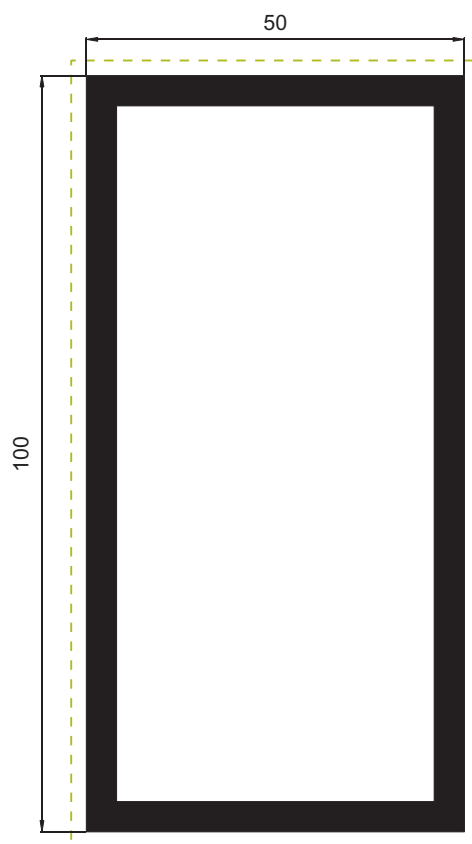

P53629

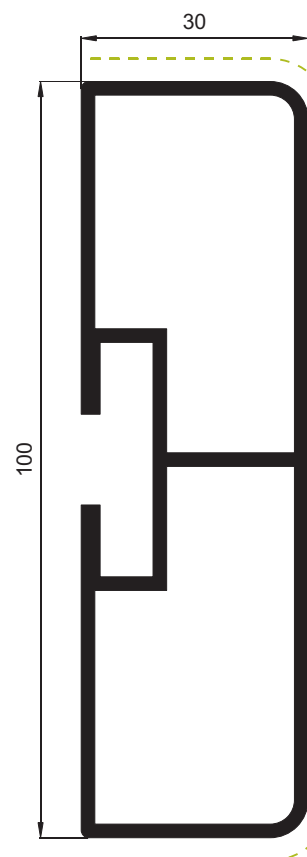

P23903

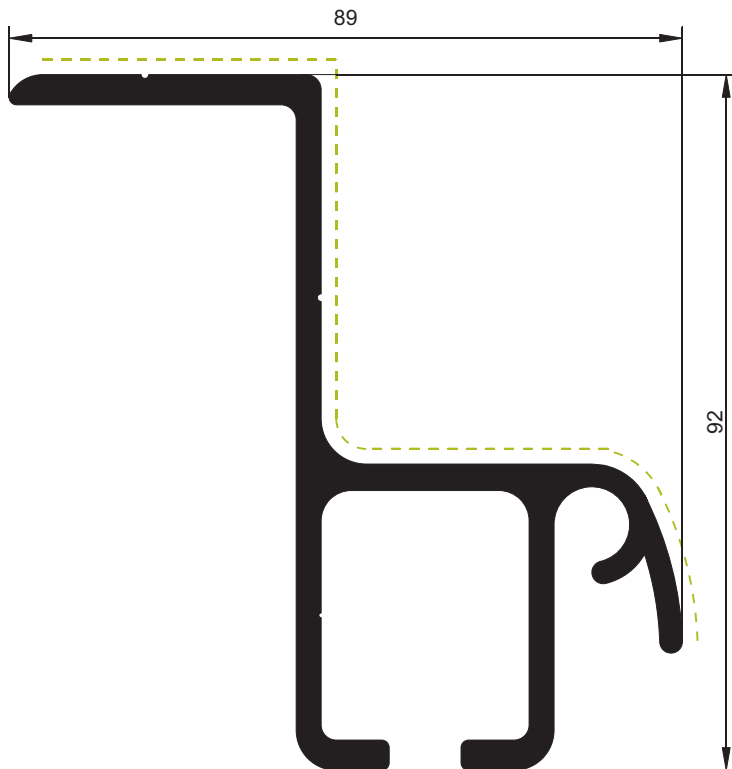

P22266

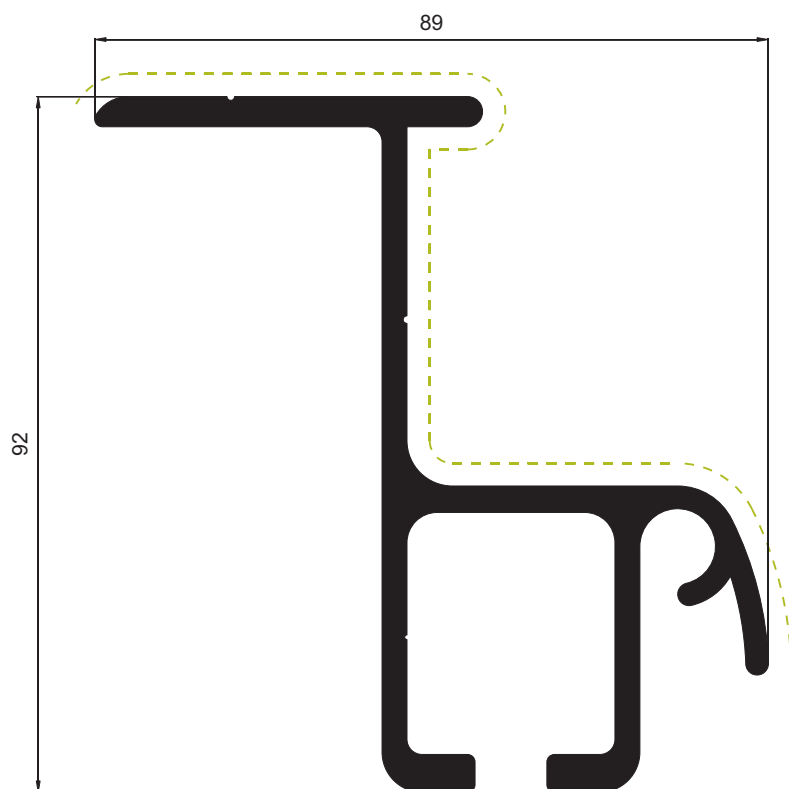

P23488

# Série de TRANSPORTES

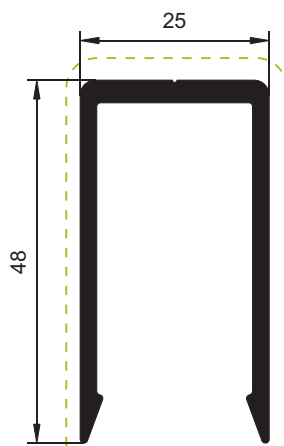

P21307

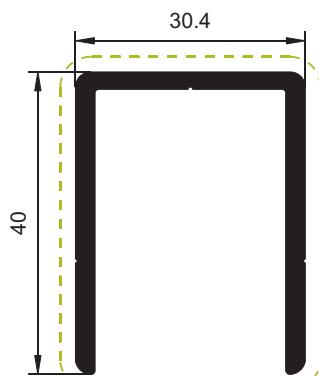

P22236

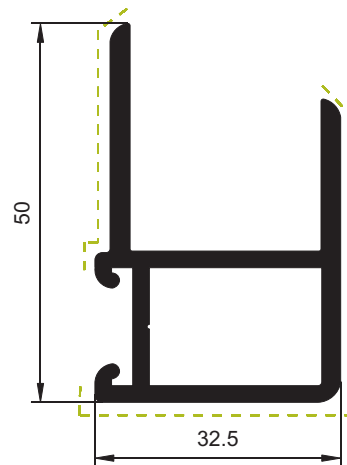

P21308

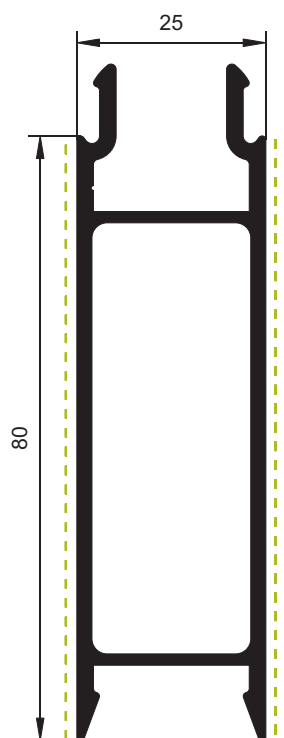

P22119

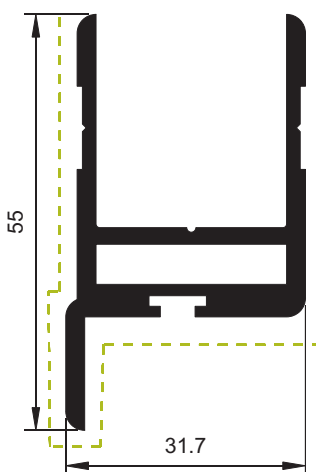

P21827

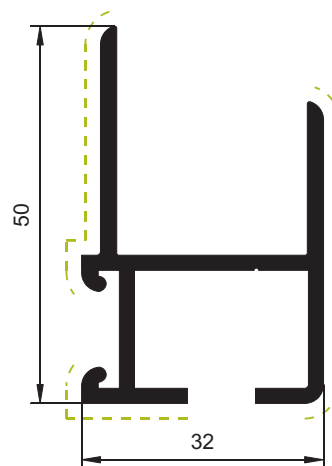

P22147

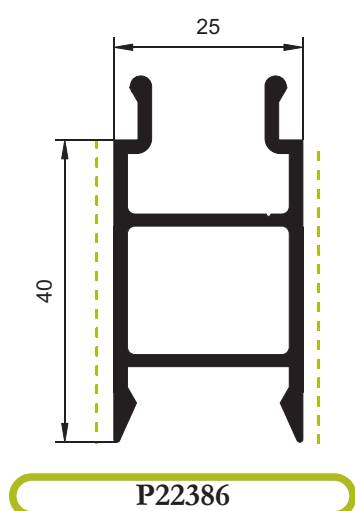
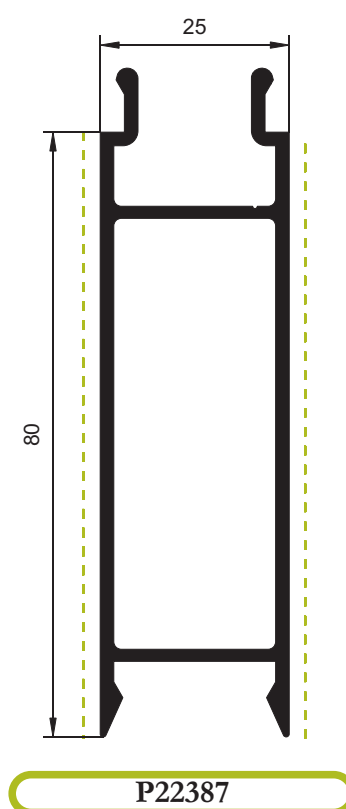
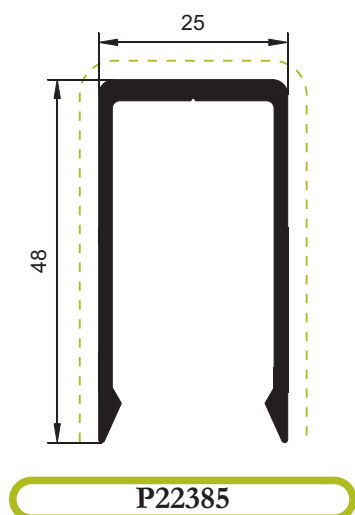

Sem escala

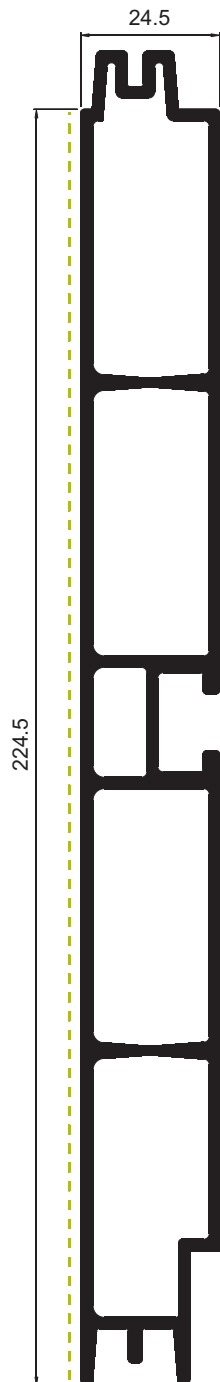

P25108

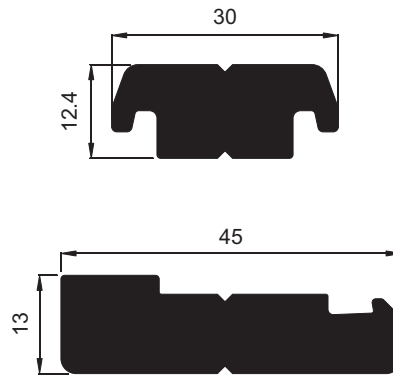

P24884

Este catálogo poderá ser sujeito a alterações por motivos técnicos, sem aviso prévio.  
Qualquer encomenda deverá ser sujeita a confirmação com os nossos serviços.

**Hydro Alumínio Portalex, S.A.**

**Sede:**

Estrada de São Marcos. 23  
2735-521 CACÉM - PORTUGAL

Tel.: (+351) 21 041 25 00

Fax: (+351) 21 041 25 28

Fax Comercial: (+351) 21 041 25 07

**Actividades de Valor Acrescentado:**

Lugar de São Carlos  
2726-901 MEM-MARTINS - PORTUGAL

Tel.: (+351) 21 041 24 00

Fax: (+351) 21 921 66 21

CONTRIBUINTE Nº 500 396 361  
REG. COMERCIAL DE SINTRA Nº: 1709  
CAPITAL SOCIAL 1.483.850,00 €  
[www.hydro.com/extrusion/portugal](http://www.hydro.com/extrusion/portugal)



**HYDRO**