

Série de correr CONFORT

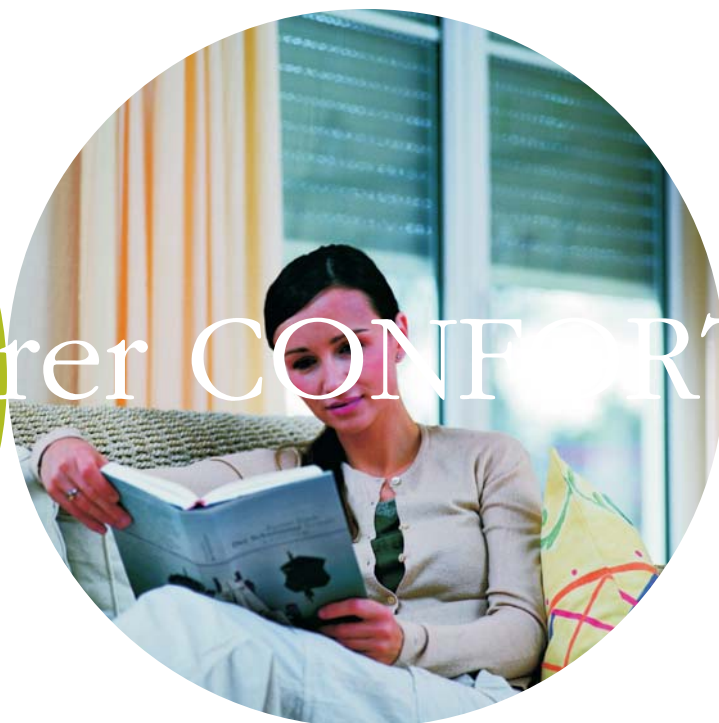

Série de correr CONFORT



A Série de correr CONFORT surgiu na continuidade das prestigiadas e tradicionais séries de catálogo da Hydro Alumínio Portalex, numa perspectiva de renovação, qualidade e modernidade. Logo desde o seu desenvolvimento, a Série de correr CONFORT mereceu a aceitação imediata do mercado e dos consumidores. Tornou-se uma referência no seu segmento como produto diferenciado e inovador, trouxe inúmeras transformações e mais-valias às actividades relacionadas com a indústria da caixilharia, e afirmou-se como uma solução global.

Vocacionada para a execução de janelas e portas de vidro duplo, em áreas de arquitectura urbana e residências tradicionais, a Série de correr CONFORT, possibilita também a aplicação com vidro simples.

A Série oferece todas as soluções possíveis, neste tipo de caixilharia e continua aberta à constante inovação e evolução.

Inserida num segmento de gama média, a Série de correr CONFORT apresenta notáveis vantagens de conforto, estéticas e económicas. Utiliza acessórios e equipamentos disponíveis no mercado e encontra-se caracterizada e classificada em conformidade com a norma NP EN 14351-1:2008, norma de produto para a Marcação



Soluções construtivas, dimensões dos perfis e vidro

- Janelas e portas de 2, 3 e 4 folhas, Tri-rail e Guilhotina;
- Profundidade dos perfis do aro, 70,5 a 73,5 mm, (em Tri-rail 106,5 a 109,7 mm);
- Profundidade dos perfis da folha, 24,8 a 66,2 mm;
- Vidro duplo até 18 mm;
- Vidro simples 4 a 6 mm;

Classificações e caracterização

Janela 2 folhas com 1600 x 2030 mm
Soleira Tubular
Vidro duplo 4+10+4

Permeabilidade ao Ar: Classe 3
Estanquidade à Água: Classe 7A
Resistência à Pressão do Vento: Classe B2

Coefficiente de Transmissão Térmica : $U_w = 3,9 \text{ W}/(\text{m}^2 \text{ K})$
 $U_f = 7,0 \text{ W}/(\text{m}^2 \text{ K})$
Desempenho Acústico: $R_w = 25 (-1; -3) \text{ dB}$

Classificações e caracterização

Janela 2 folhas com 1800 x 1200 mm
Soleira Sólida
Vidro duplo 4+10+4

Permeabilidade ao Ar: Classe 3
Estanquidade à Água: Classe 4A
Resistência à Pressão do Vento: Classe B4





Coefficiente de Transmissão Térmica : $U_w = 4,3 \text{ W}/(\text{m}^2 \text{ K})$
 $U_f = 7,0 \text{ W}/(\text{m}^2 \text{ K})$
Desempenho Acústico: $R_w = 26 (-1; -2) \text{ dB}$

Índice



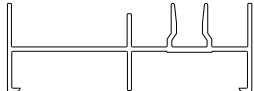

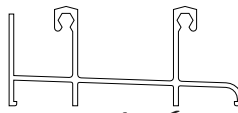
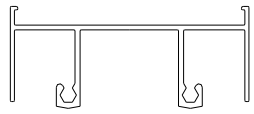
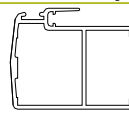
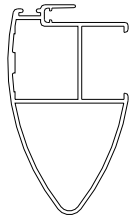
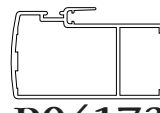
● Índice visual	03
● Perfis	
. Apainelado	07
. Janela dupla	08
. Tri-rail	10
. Prumadas	11
. Soleiras	12
. Travessas	14
. Vergas	15
. Ombreiras	15
. Diversos	15
. Solução vidro simples	16
● Pormenores	17
● Acessórios	21
● Nomenclatura	23

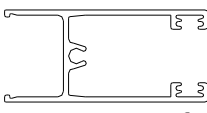

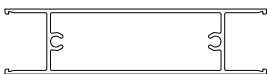
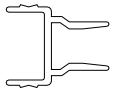

Série de correr CONFORT

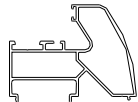
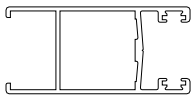
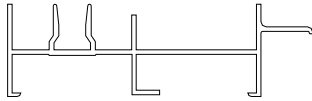
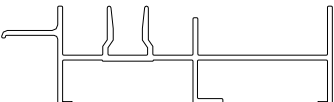
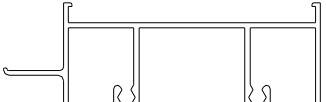
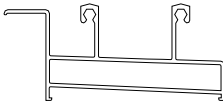
Desenho Referência	Designação	Peso [Kg/m]	Área Trat. [m ² /m]	M. Inércia [cm ⁴]	Pág.
 P04167	Ombreira	0,625	0,353	I _x = 0,79 I _y = 14,25	15
 P04168	Soleira caixa	0,963	0,347	I _x = 4,26 I _y = 18,07	12
 P04169	Soleira aberta	0,726	0,361	I _x = 2,16 I _y = 12,45	12
 P04170	Verga	0,729	0,384	I _x = 2,12 I _y = 14,90	15
 P04171	Prumada	0,590	0,218	I _x = 3,17 I _y = 3,44	11
 P04172	Prumada	0,903	0,268	I _x = 14,95 I _y = 5,59	11
 P04173	Prumada	0,700	0,250	I _x = 4,06 I _y = 8,07	11
 P04175	Prumada	0,670	0,258	I _x = 3,26 I _y = 6,49	11
 P04176	Travessa	0,623	0,337	I _x = 2,54 I _y = 6,08	14



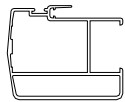
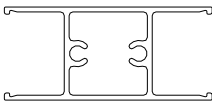

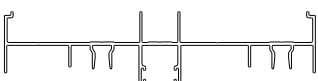
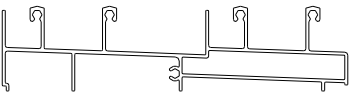
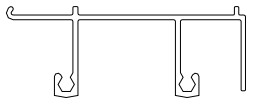
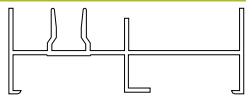
Série de correr CONFORT

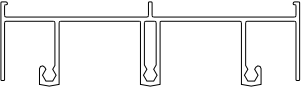
Desenho Referência	Designação	Peso [Kg/m]	Área Trat. [m ² /m]	M. Inércia [cm ⁴]	Pág.
 P04177	Travessa	1,165	0,445	I _x = 4,79 I _y = 47,11	14
 P04178	Travessa	1,006	0,318	I _x = 4,11 I _y = 33,14	14
 P04179	Postiço	0,238	0,125	I _x = 0,33 I _y = 0,27	15
 P04182	Redutor	0,201	0,110	I _x = 0,24 I _y = 0,46	15
 P04377	Perfil de ligação	1,199	0,377	I _x = 10,41 I _y = 22,08	15
 P04381	Prumada	0,730	0,285	I _x = 3,53 I _y = 7,89	11
 P04382	Ombreira	0,710	0,399	I _x = 1,00 I _y = 18,80	07
 P04383	Ombreira	0,710	0,469	I _x = 1,00 I _y = 17,86	07
 P04384	Verga	0,804	0,419	I _x = 2,22 I _y = 19,53	07
 P04385	Soleira	1,050	0,379	I _x = 5,32 I _y = 22,34	07

Série de correr CONFORT

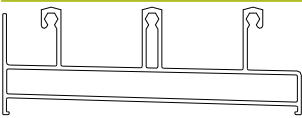
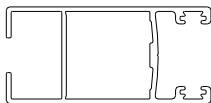
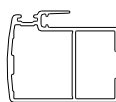
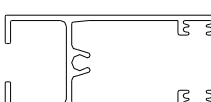
Desenho Referência	Designação	Peso [Kg/m]	Área Trat. [m ² /m]	M. Inércia [cm ⁴]	Pág.
 P04509	Prumada	1,052	0,269	I _x = 9,73 I _y = 12,71	11
 P04553	Travessa	0,640	0,227	I _x = 2,28 I _y = 4,76	14
 P04847	Soleira	0,742	0,382	I _x = 1,11 I _y = 20,16	12
 P04888	Ombreira	1,677	0,819	I _x = 178,87 I _y = 17,51	08
 P04889	Soleira	2,146	0,815	I _x = 9,78 I _y = 228,10	09
 P04890	Verga	0,656	0,332	I _x = 1,90 I _y = 10,98	08
 P04993	Ombreira	0,656	0,370	I _x = 0,93 I _y = 14,63	15
 P05160	Soleira	0,956	0,346	I _x = 4,26 I _y = 17,51	13
 P05250	Ombreira tri-rail	0,817	0,425	I _x = 0,82 I _y = 42,0	10
 P05251	Verga tri-rail	1,128	0,511	I _x = 3,21 I _y = 47,58	10

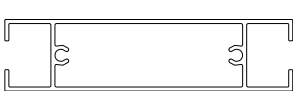
Série de correr CONFORT

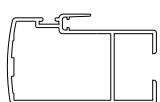
Desenho Referência	Designação	Peso [Kg/m]	Área Trat. [m ² /m]	M. Inércia [cm ⁴]	Pág.
 P05252	Soleira tri-rail	1,445	0,460	I _x = 6,26 I _y = 57,97	10
 P05389	Prumada	0,760	0,303	I _x = 3,61 I _y = 9,32	16
 P05390	Prumada	0,633	0,239	I _x = 3,29 I _y = 4,31	16
 P05391	Travessa	0,680	0,351	I _x = 2,65 I _y = 7,26	16
 P05392	Travessa	1,217	0,463	I _x = 4,90 I _y = 52,00	16
 P05393	Travessa	1,094	0,265	I _x = 4,33 I _y = 10,86	16
 P05678	Soleira	0,473	0,225	I _x = 1,35 I _y = 2,54	13
 P05776	Prumada	0,741	0,271	I _x = 16,38 I _y = 33,34	16

NOTA: Os momentos de inércia aqui apresentados são calculados com base no eixo

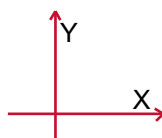

com a posição dos perfis indicada neste índice.

Série de correr CONFORT

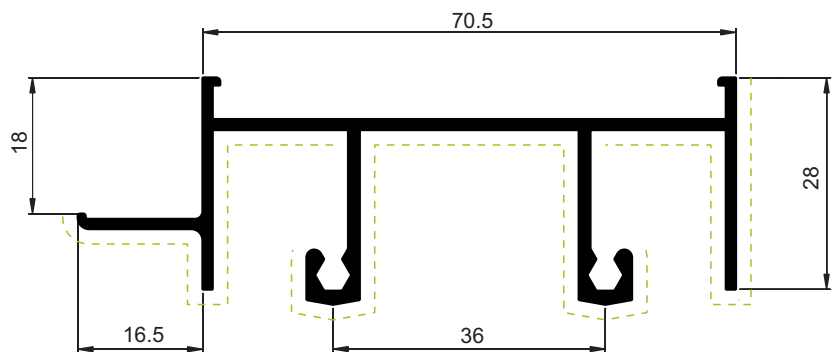

P04384 Verga Apainelado

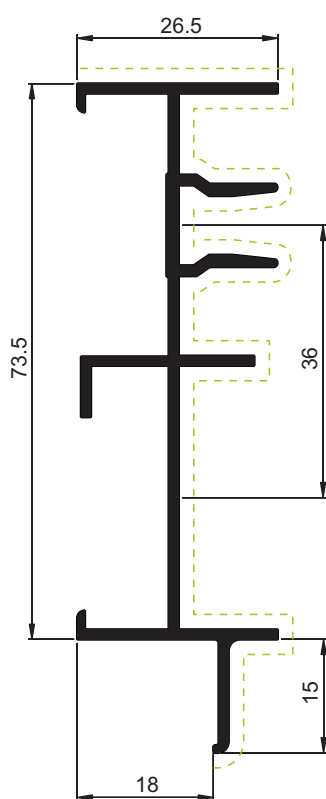

P04382 Ombreira

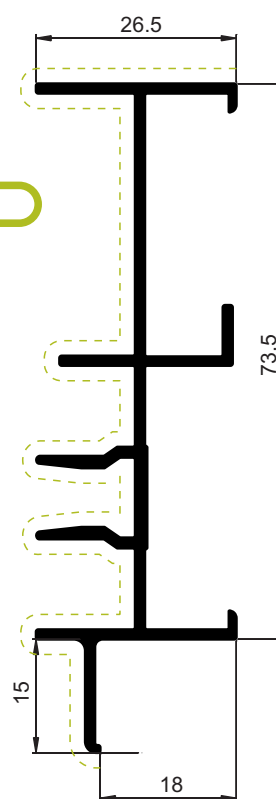

P04383 Ombreira

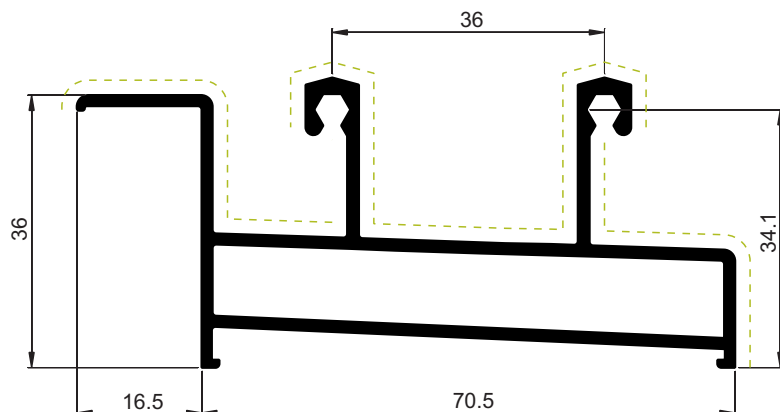

P04385 Soleira Apainelado

Série de correr CONFORT

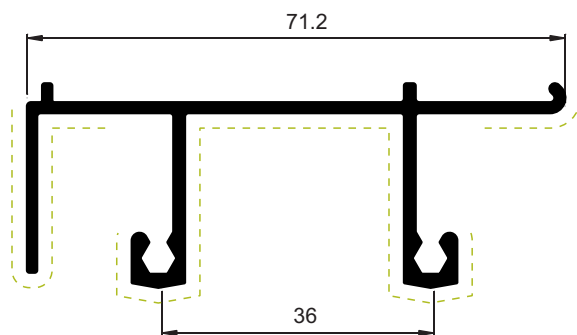

P04890 Verga Jan.

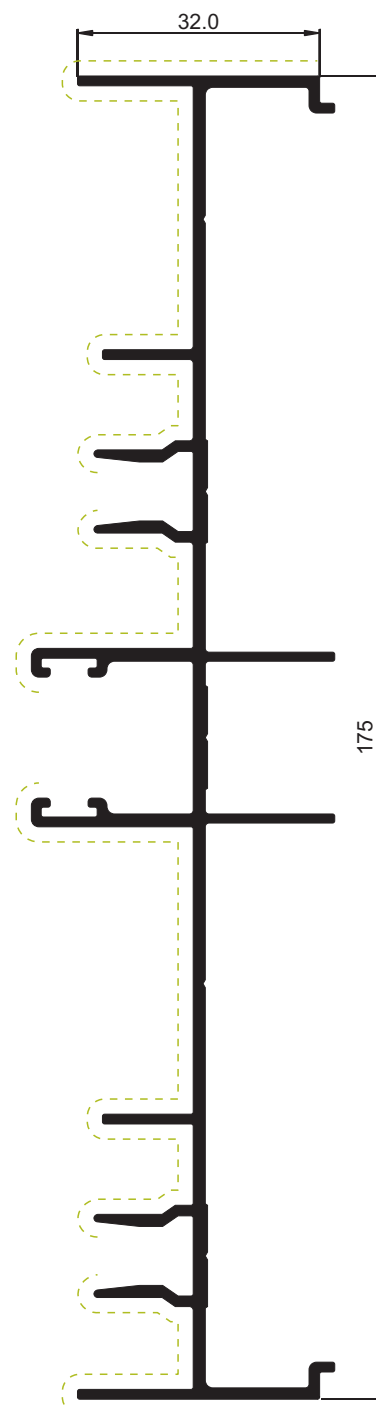

P04888 Ombreira Jan.

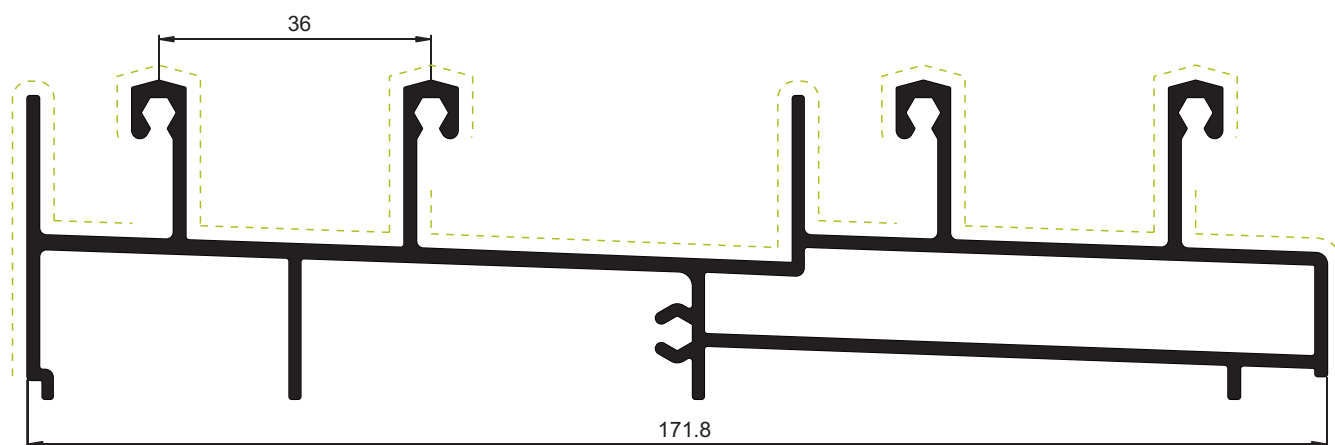

P04889 Soleira Jan.

Série de correr CONFORT

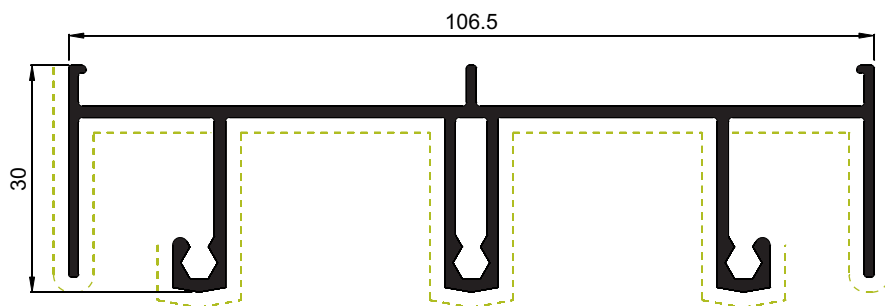

P05251 Verga Tri-

P05250 Ombreira Tri-

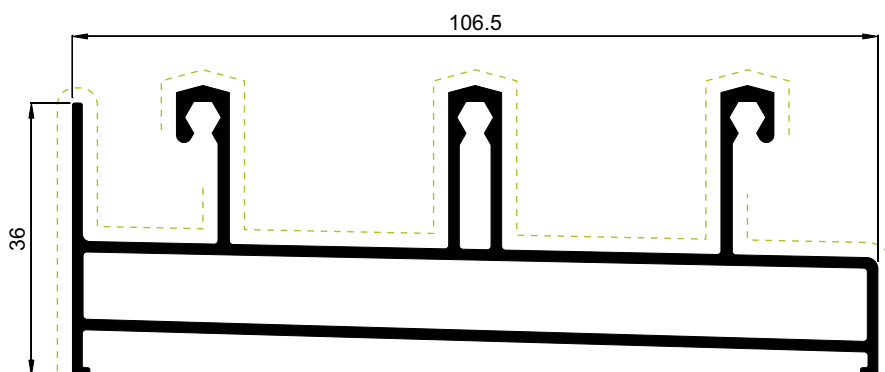
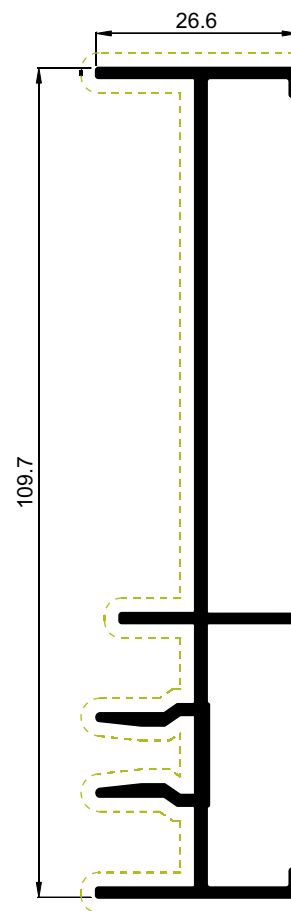

P05252 Soleira Tri-

Série de correr CONFORT

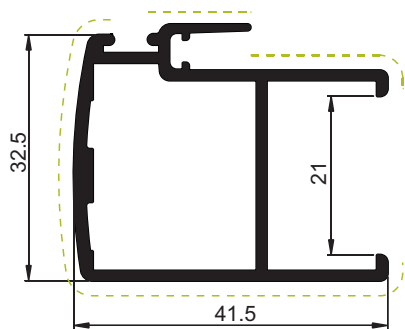

P04171 Prumada

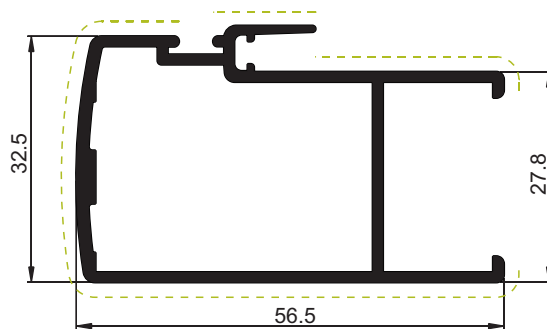

P04173 Prumada

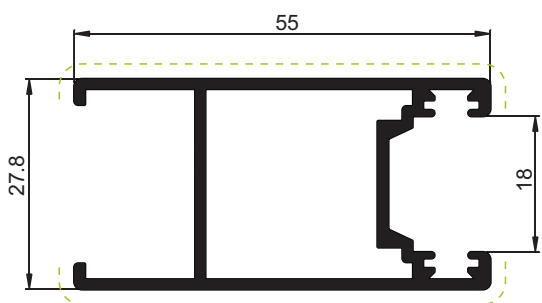

P04175 Prumada

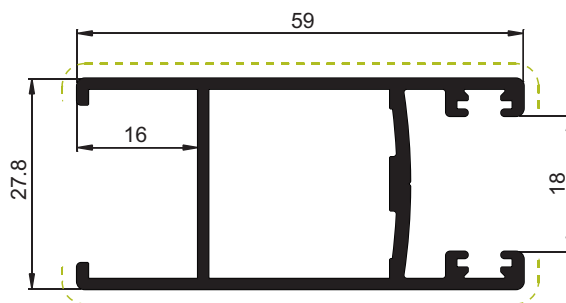

P04381 Prumada

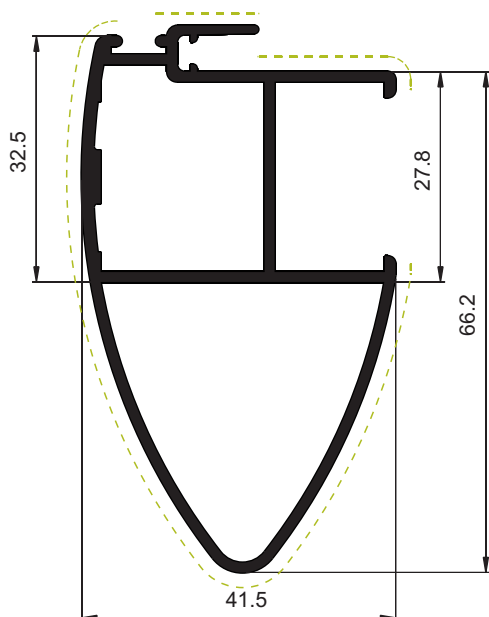

P04172 Prumada

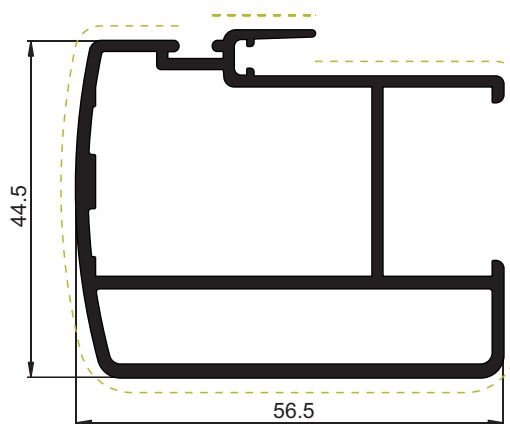

P04509 Prumada

Série de correr CONFORT

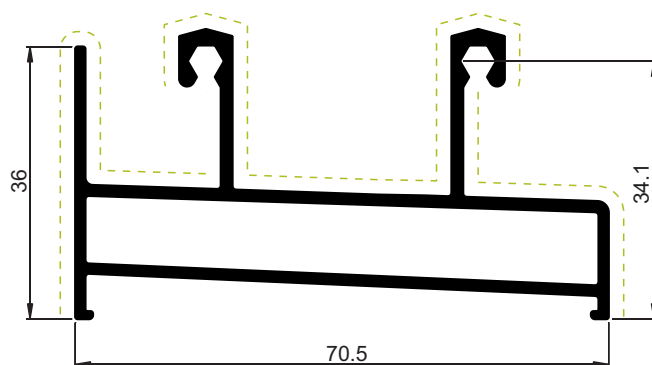

P04168 Soleira

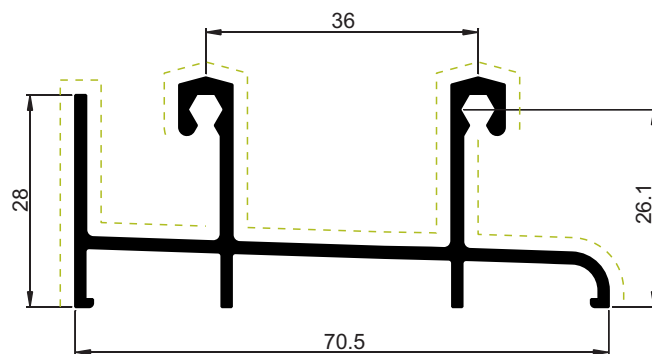

P04169 Soleira

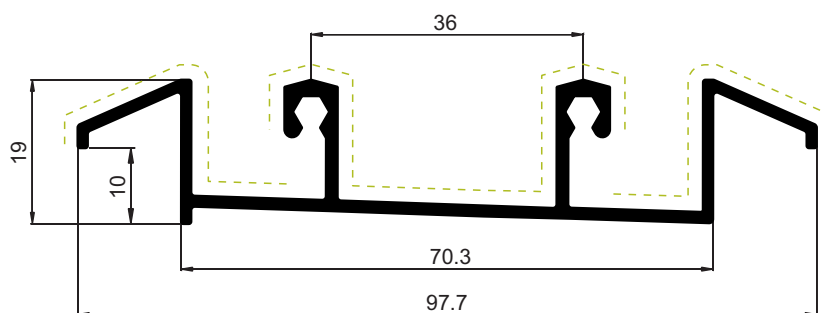

P04847 Soleira

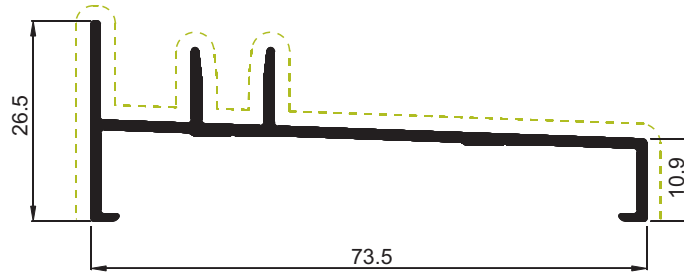

P05678 Soleira

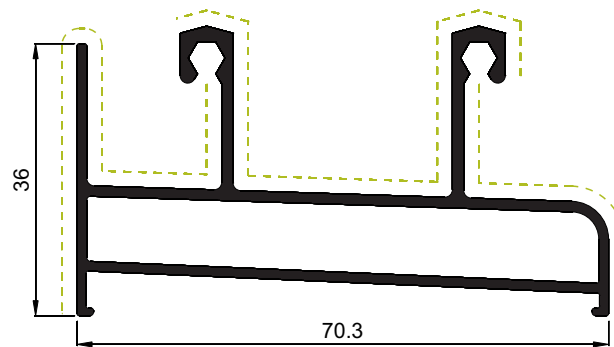

P05160 Soleira

Série de correr CONFORT

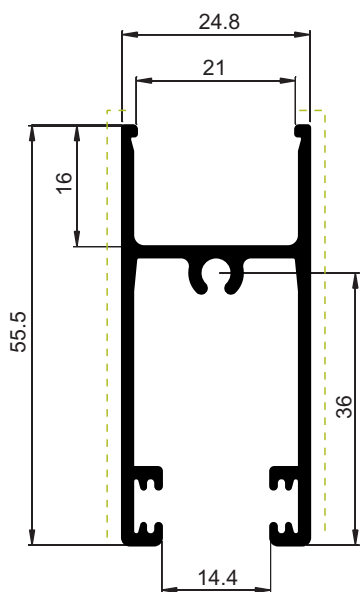

P04176

Travessa

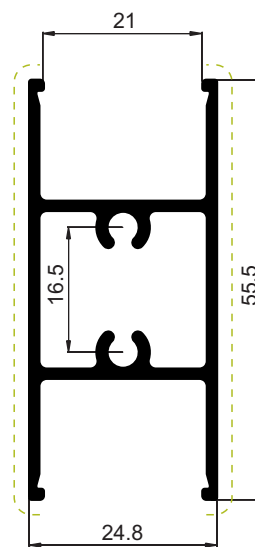

P04553

Travessa

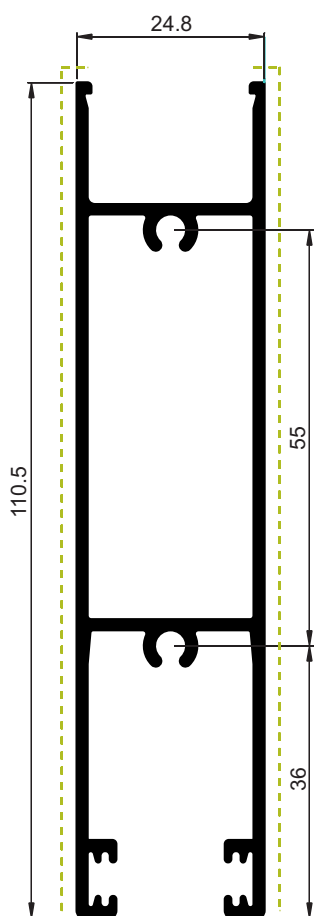

P04177

Travessa

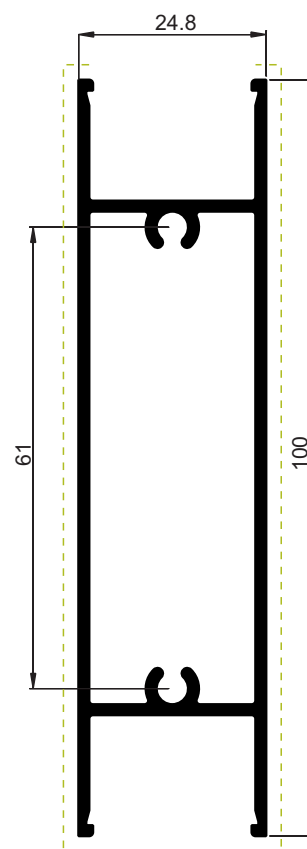

P04178

Travessa

Série de correr CONFORT

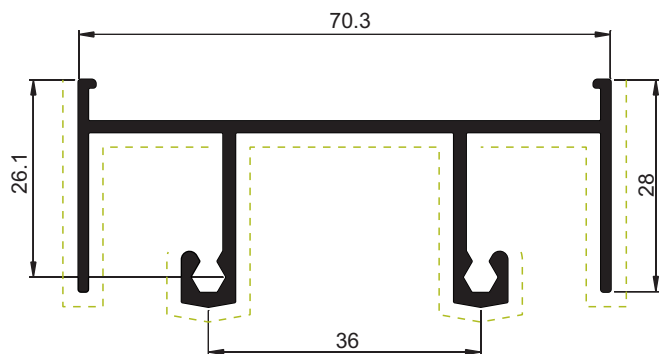

P04170

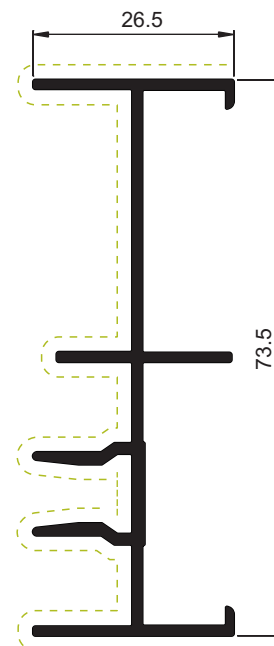

P04167

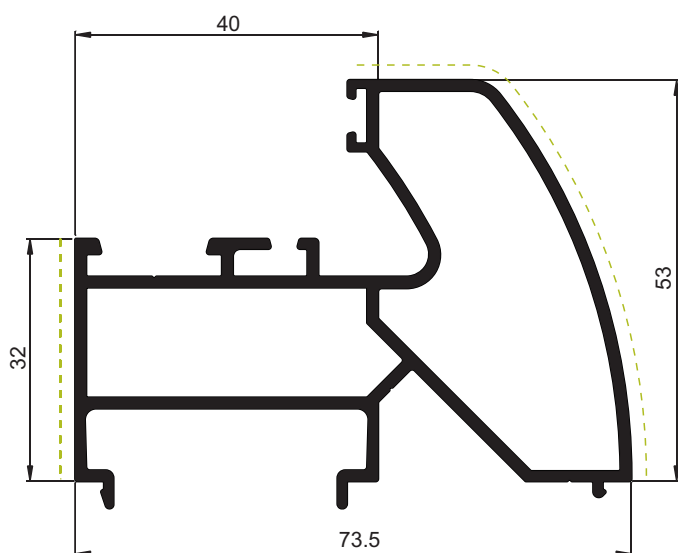

P04377 Perfil de

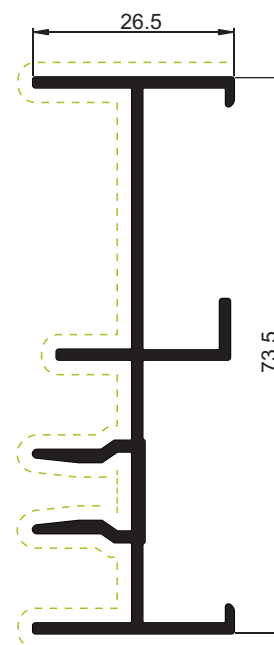

P04993

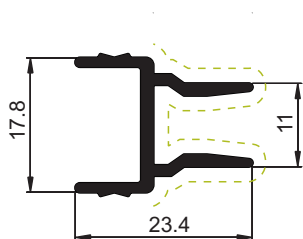

P04179 Postiço 3 e 4

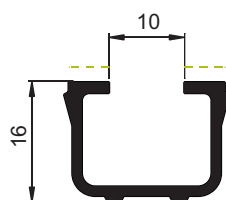

P04182 Redutor

Série de correr CONFORT

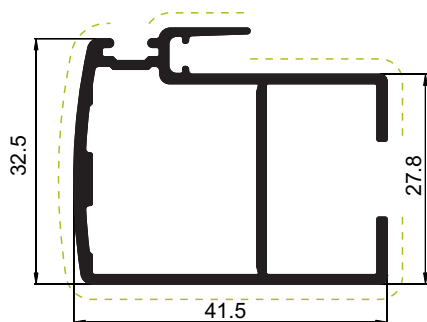

P05390

Prumada

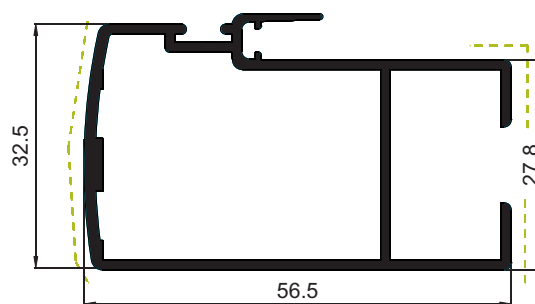

P05776

Prumada

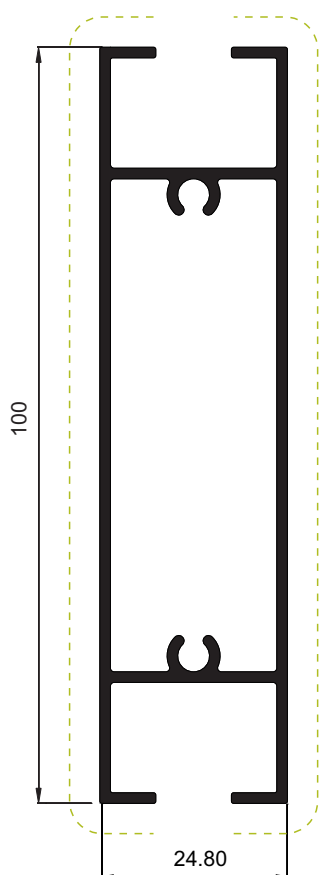

P05393

Travessa

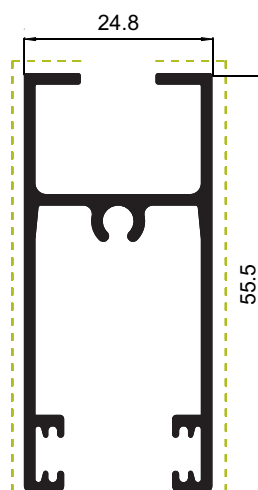

P05391

Travessa

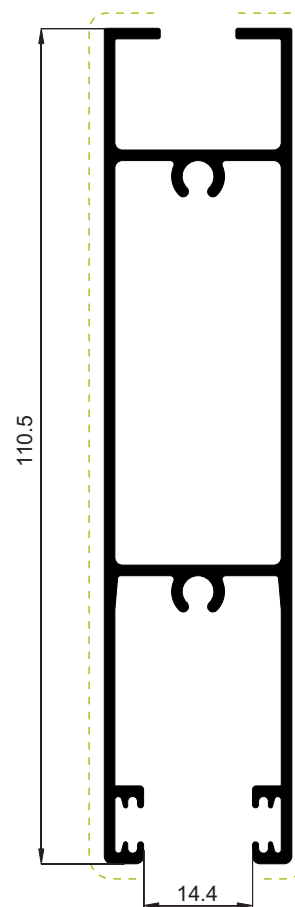

P05392

Travessa

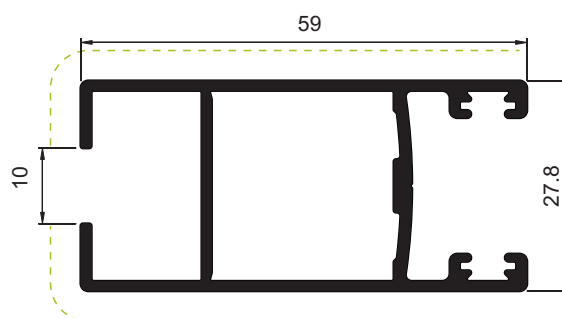

P05389

Prumada

Série de correr CONFORT

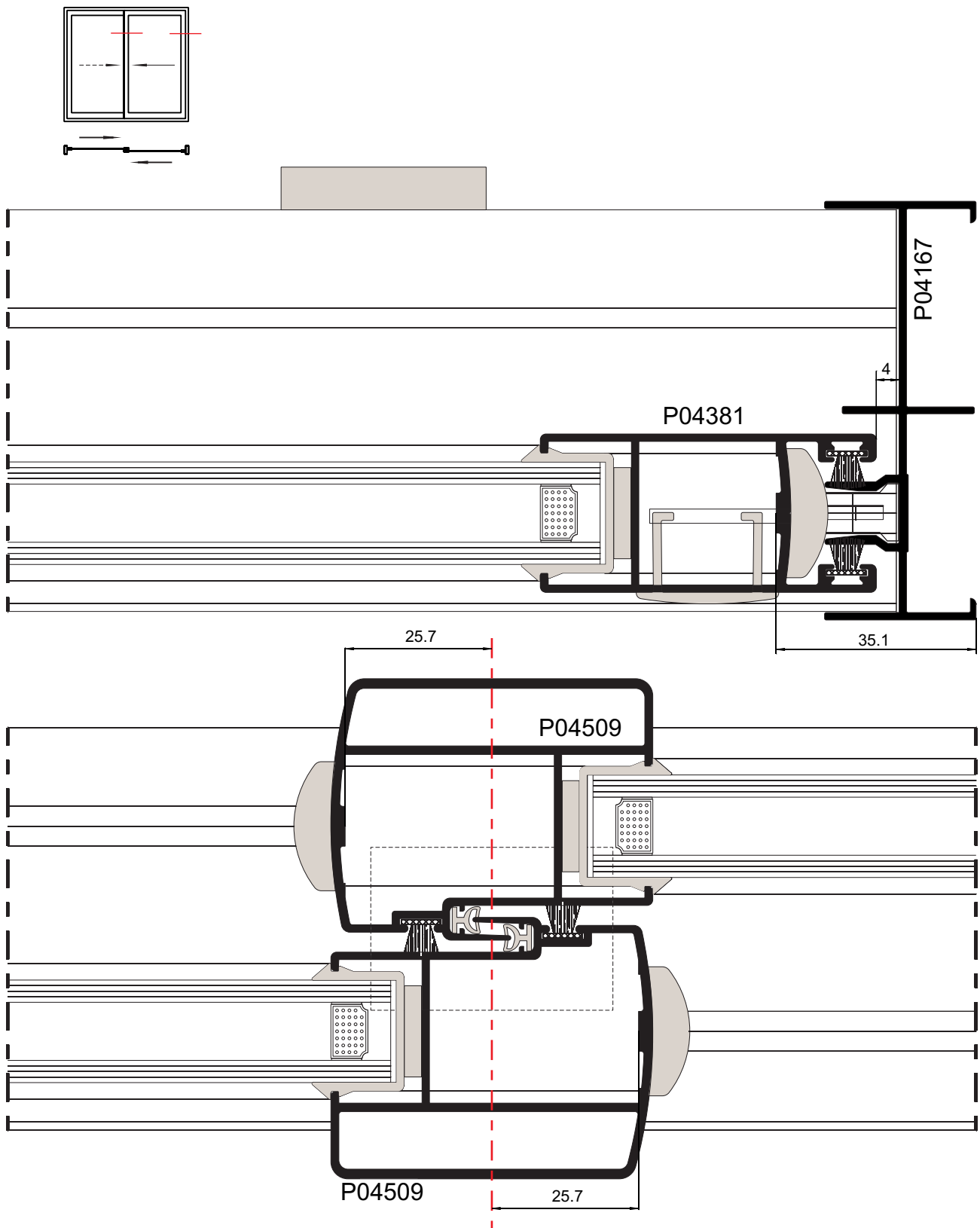

Série de correr CONFORT

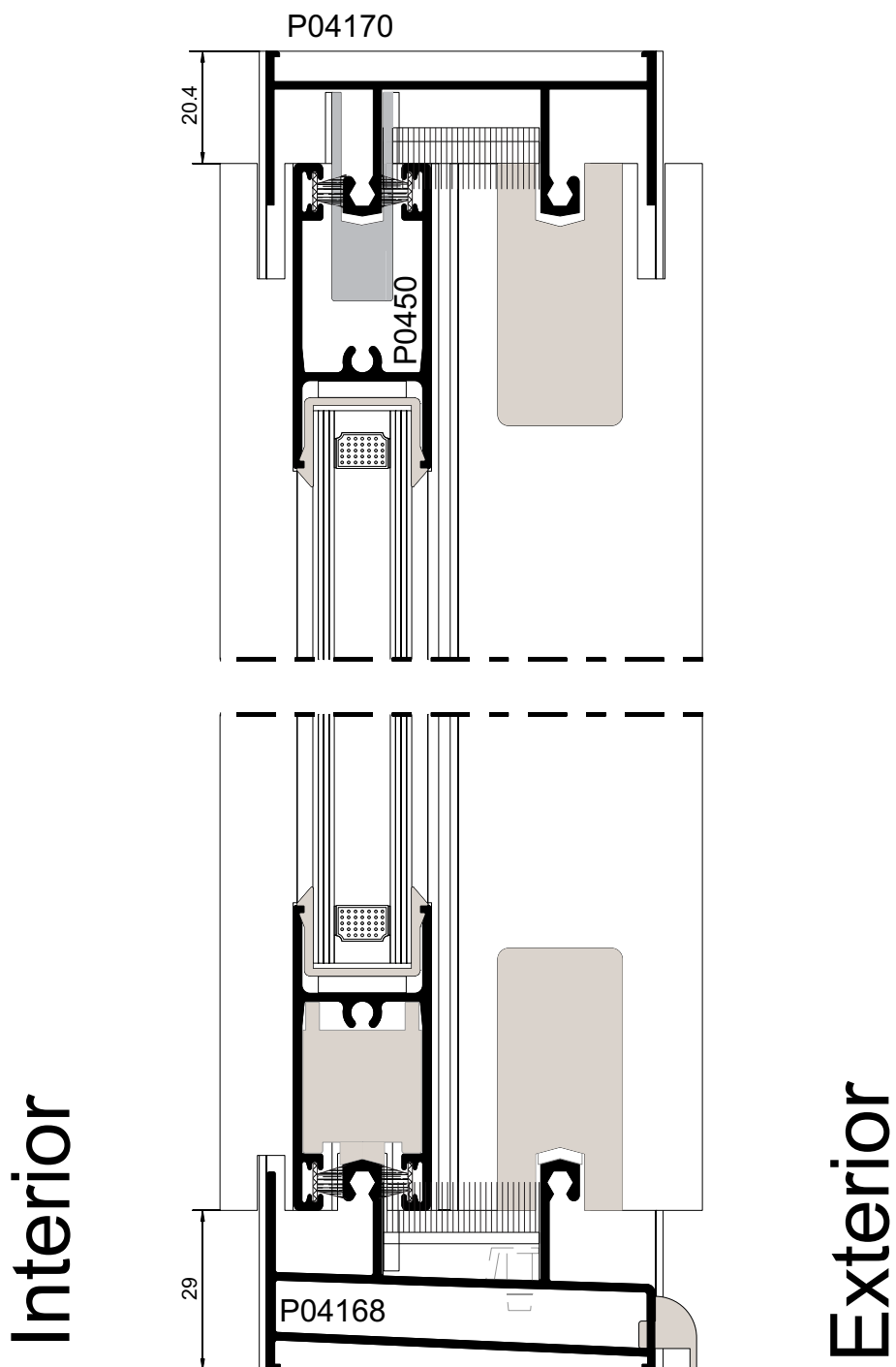
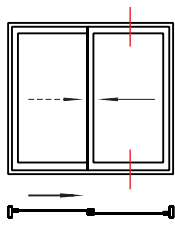

Sem escala

Série de correr CONFORT

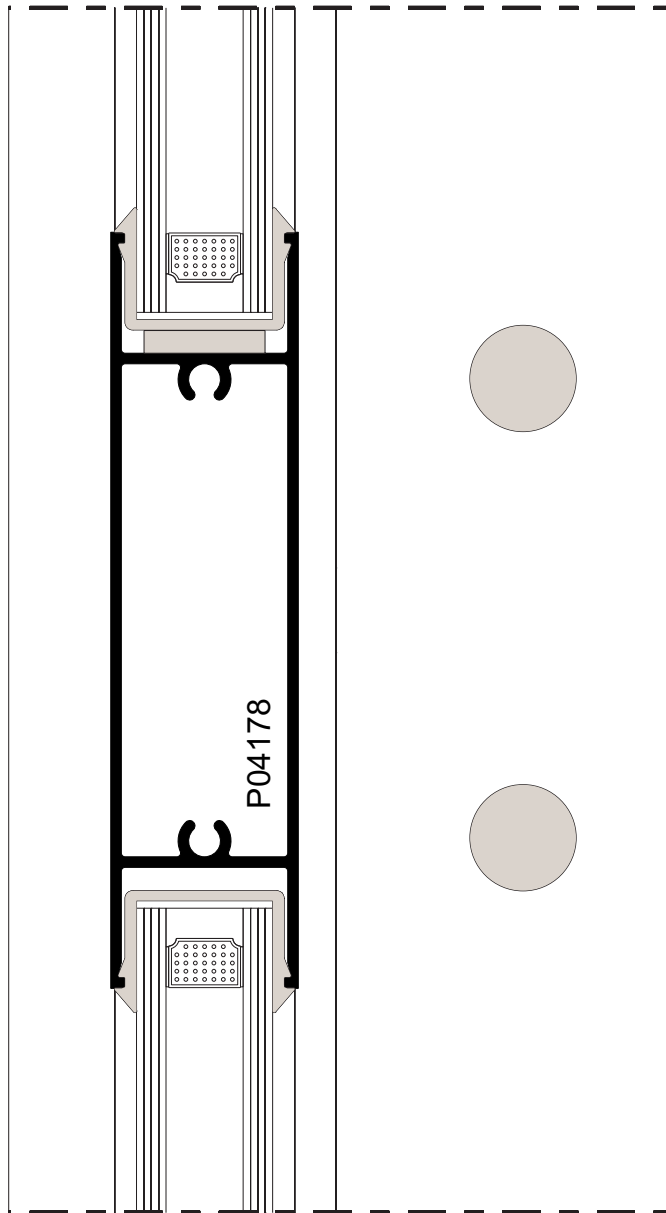
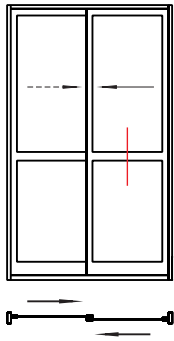

Série de correr CONFORT

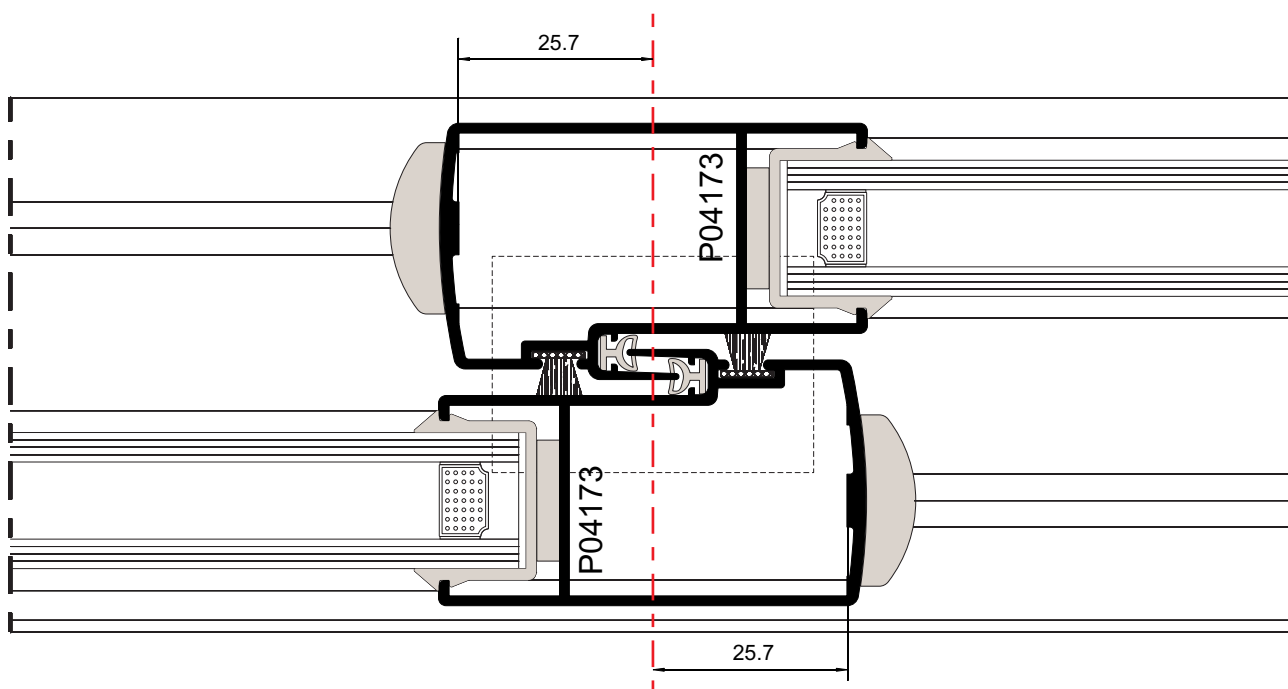
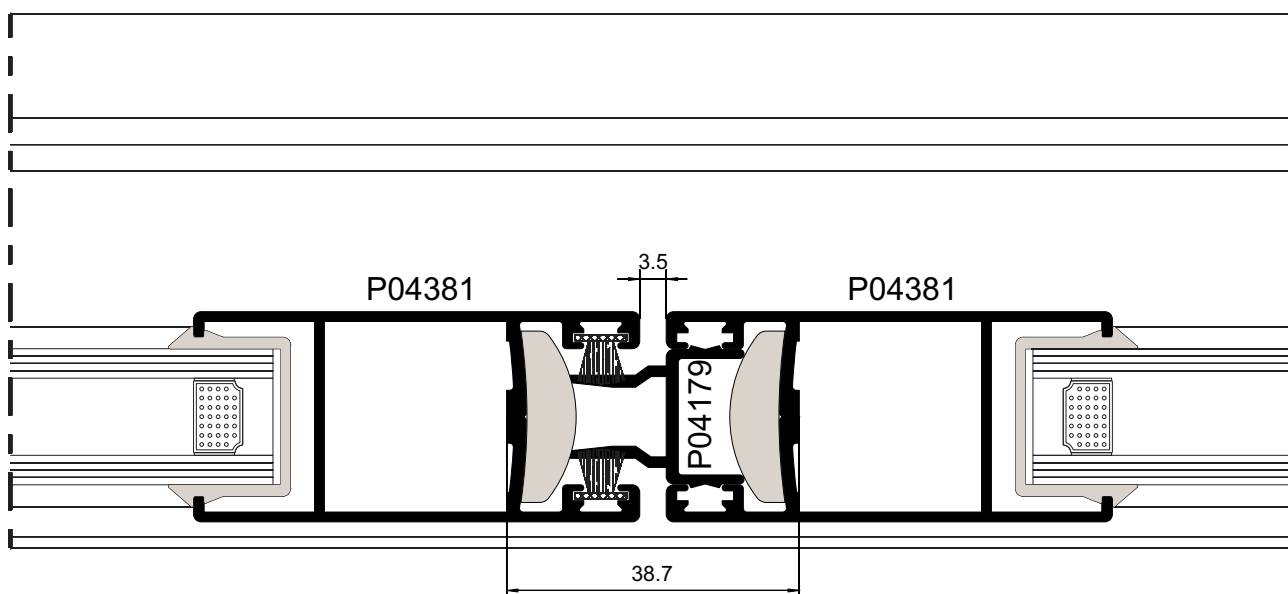
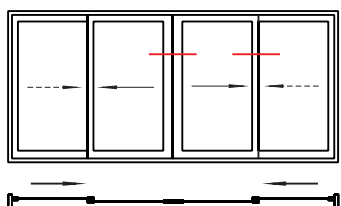

Série de correr CONFORT

Representação	Designação	Referência	Contactos	Notas
	Cortante	CONFORT	M.J. BRANCO, Lda. Marina Branco Tel: 214 480 400 Fax: 214 480 409 geral@mjbranco.pt	
	Cortante	Nº 11	CUNCORTAVE, Lda. Sérgio Santos Tel: 252 319 196/7 Fax: 252 319 198 geral@cuncortave.com	
	Fecho de embutir	247i	ALUALPHA, S.A. Rui Ribeiro Tel: 219 612 434 Fax: 219 615 902 info@alualpha.pt	
	Gancho	G1G+	ALUALPHA, S.A. Rui Ribeiro Tel: 219 612 434 Fax: 219 615 902 info@alualpha.pt	
	Gache	G15	ALUALPHA, S.A. Rui Ribeiro Tel: 219 612 434 Fax: 219 615 902 info@alualpha.pt	
	Vedante vidro duplo 18 mm	P1145-100-E1	PERVEDANT Tel: 244 830 650 Fax: 244 830 659 info@pervedant.com	Vedante em "U"
	Vedante vidro duplo 18 mm	P1250-100-E1	PERVEDANT Tel: 244 830 650 Fax: 244 830 659 info@pervedant.com	Vedante tipo "cunha"
	Vedante vidro duplo 16 mm	P1251-100-E1	PERVEDANT Tel: 244 830 650 Fax: 244 830 659 info@pervedant.com	Vedante tipo "cunha"
	Vedante vidro simples 5 a 6 mm	P1163-100-E1	PERVEDANT Tel: 244 830 650 Fax: 244 830 659 info@pervedant.com	Vedante em "U"
	Vedante prumadas centrais	PDD-52-4.6	PERVEDANT Tel: 244 830 650 Fax: 244 830 659 info@pervedant.com	

Série de correr CONFORT

Representação	Designação	Referência	Contactos	Notas
	Junta de estanquidade	C18	POLISMAR, Lda. Mário Rodrigues Tel: 219 217 729 Fax: 219 201 410 mariorodrigues@polismar.pt	Fornecido em kit
	Calço do vidro	5012	POLISMAR, Lda. Mário Rodrigues Tel: 219 217 729 Fax: 219 201 410 mariorodrigues@polismar.pt	
	Goteira com válvula	9001P	POLISMAR, Lda. Mário Rodrigues Tel: 219 217 729 Fax: 219 201 410 mariorodrigues@polismar.pt	Fornecido em kit
	Deflector Goteira	717P	POLISMAR, Lda. Mário Rodrigues Tel: 219 217 729 Fax: 219 201 410 mariorodrigues@polismar.pt	Fornecido em kit
	Rolamento	9112	POLISMAR, Lda. Mário Rodrigues Tel: 219 217 729 Fax: 219 201 410 mariorodrigues@polismar.pt	Fornecido em kit
	Guia das folhas	1017P	POLISMAR, Lda. Mário Rodrigues Tel: 219 217 729 Fax: 219 201 410 mariorodrigues@polismar.pt	Fornecido em kit
	Placa de vedação	1018P	POLISMAR, Lda. Mário Rodrigues Tel: 219 217 729 Fax: 219 201 410 mariorodrigues@polismar.pt	Fornecido em kit
	Topo prumada	1016P	POLISMAR, Lda. Mário Rodrigues Tel: 219 217 729 Fax: 219 201 410 mariorodrigues@polismar.pt	
	Calço do aro	5004	POLISMAR, Lda. Mário Rodrigues Tel: 219 217 729 Fax: 219 201 410 mariorodrigues@polismar.pt	
	Pelúcia	6.9x7.0 mm Stop-Fin	Mercado	
	Silicone	0892-210 2	Wurth	

- 1 - Lintel, padieira ou verga
- 2 - Bandeira
- 3 - Travessa superior
- 4 - Travessa intermédia
- 5 - Folha de janela ou porta
- 6 - Couceira
- 7 - Tábua de peito, tábua de soleira, soleira
- 8 - Travessa superior da folha
- 9 - Couceira da folha
- 10 - Travessa inferior da folha
- 11 - Montante
- 12 - Tábua de peito/soleira
- 13 - Pinázio

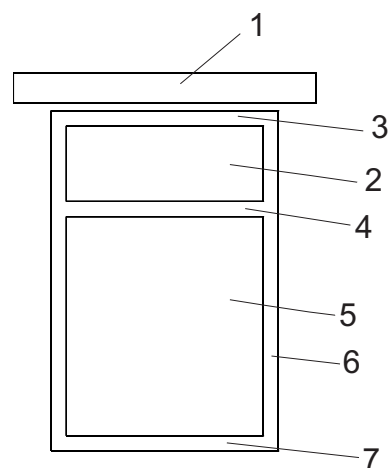
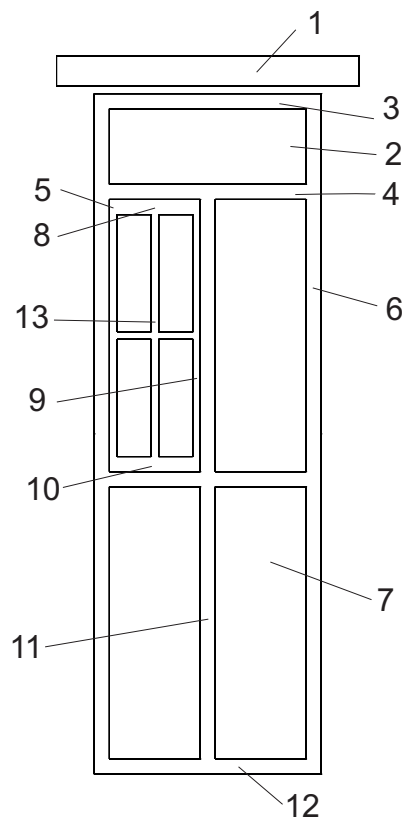

Designações das componente de janelas e portas de acordo com a NP EN 12519 de 2008.

Este catálogo poderá ser sujeito a alterações por motivos técnicos, sem aviso prévio.
Qualquer encomenda deverá ser sujeita a confirmação com os nossos serviços.

Hydro Alumínio Portalex, S.A.

Sede:

Estrada de São Marcos. 23
2735-521 CACÉM - PORTUGAL

Tel.: (+351) 21 041 25 00

Fax: (+351) 21 041 25 28

Fax Comercial: (+351) 21 041 25 07

Actividades de Valor Acrescentado:

Lugar de São Carlos
2726-901 MEM-MARTINS - PORTUGAL

Tel.: (+351) 21 041 24 00

Fax: (+351) 21 921 66 21

CONTRIBUINTE Nº 500 396 361

REG. COMERCIAL DE SINTRA Nº: 1709

CAPITAL SOCIAL 1.483.850,00 €

www.hydro.com/extrusion/portugal



HYDRO