



Série de correr CLT85

Série de correr CLT85

A Hydro Alumínio Portalex dedica-se à extrusão de perfis de alumínio de secções variadas, com maior ou menor complexidade, consoante as necessidades dos clientes.

A extrusão de alumínio permite toda a liberdade de concepção em termos de design, de forma a ir de encontro às diferentes necessidades.

Diferentes ligas e ciclos de tratamento térmico, conferem ao produto final distintas propriedades mecânicas, pelo que uma boa definição inicial de características é essencial.

Vocacionada para a execução de janelas e portas de vidro simples, em áreas de arquitectura urbana e residências tradicionais, a **Série de correr CLT85**, possibilita também a aplicação com vidro duplo.

Inserida num segmento de gama média, a **Série de correr CLT85** apresenta como principais vantagens soluções construtivas tradicionais e a economia. Utiliza acessórios e equipamentos disponíveis no mercado e encontra-se caracterizada e classificada em conformidade com a norma NP EN 14351-1:2008, norma de produto para a Marcação CE.



Soluções construtivas, dimensões dos perfis e vidro

- Janelas e portas de 2, 3 e 4 folhas, Tri-rail, Guilhotina e Janela Dupla.
- Profundidade dos perfis do aro, 69 a 72,1 mm, (em Tri-rail 103 a 106,6 mm e em Janela Dupla 159 a 162 mm);
- Profundidade dos perfis da folha, 23,3 a 23,6 mm;
- Vidro simples 4 a 6 mm;
- Vidro duplo até 16 mm.

Classificações e caracterização

Janela 2 folhas com 1800 x 1200 mm

- Vidro simples 5 mm

- Permeabilidade ao Ar: Classe 3
- Estanquidade à Água: Classe 4A
- Resistência à Pressão do Vento: Classe B4

- Coeficiente de Transmissão Térmica : $U_w = 6,1 \text{ W}/(\text{m}^2 \text{ K})$
 $U_f = 7,0 \text{ W}/(\text{m}^2 \text{ K})$

- Desempenho Acústico: $R_w = 28 (-1; -1) \text{ dB}$





Índice





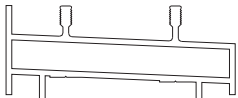
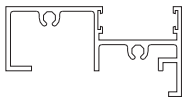
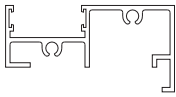

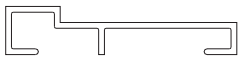
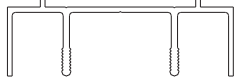
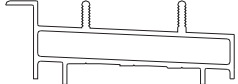
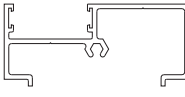
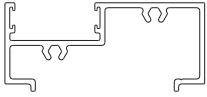

● Índice visual	03
● Perfis	
. Prumadas	10
. Travessas	13
. Ombreiras	16
. Soleiras	18
. Vergas	20
. Diversos	21
● Pormenores	22
● Acessórios	24
● Nomenclatura	25

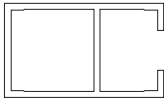
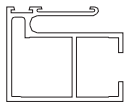
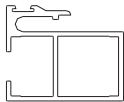
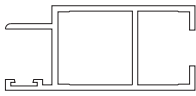

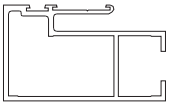
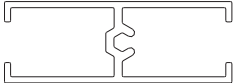
Série de correr CLT85

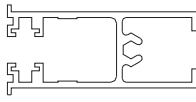
Desenho Referência	Designação	Peso [Kg/m]	Área Trat. [m ² /m]	M. Inércia [cm ⁴]	Pág.
 P00232	Soleira	1,192	0,288	Ix = 2,32 Iy = 22,7	19
 P00675	Ombreira	0,980	0,405	Ix = 2,96 Iy = 20,69	16
 P00676	Ombreira	0,924	0,405	Ix = 2,96 Iy = 20,70	16
 P01641	Remate	0,211	0,103	Ix = -- Iy = --	21
 P01665	Postiço vidro duplo	0,322	0,139	Ix = -- Iy = --	21
 P01673	Perfil ligação	0,602	0,251	Ix = 0,4 Iy = 13,37	21
 P01677	Verga	0,763	0,383	Ix = 1,44 Iy = 16,16	20
 P01679	Soleira	1,073	0,307	Ix = 2,37 Iy = 22,89	19
 P01680	Ombreira	0,825	0,365	Ix = 2,53 Iy = 18,42	16
 P01681	Ombreira	0,875	0,371	Ix = 2,68 Iy = 19,70	16





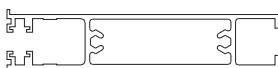
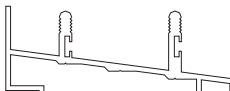
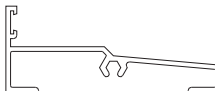
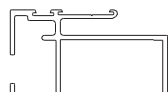
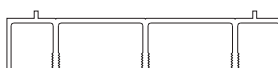
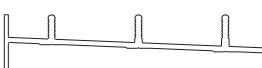

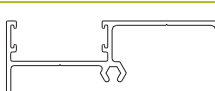
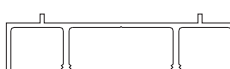
Série de correr CLT85

Desenho Referência	Designação	Peso [Kg/m]	Área Trat. [m ² /m]	M. Inércia [cm ⁴]	Pág.
 P01682	Prumada	0,554	0,180	I _x = 1,82 I _y = 3,55	10
 P01683	Prumada	0,738	0,261	I _x = 3,50 I _y = 4,38	11
 P01684	Prumada 3 folhas	0,739	0,245	I _x = 3,40 I _y = 4,76	11
 P01685	Prumada 4 folhas	0,667	0,234	I _x = 2,16 I _y = 5,87	11
 P01686	Prumada	0,676	0,210	I _x = 2,37 I _y = 8,28	10
 P01687	Prumada	0,862	0,284	I _x = 4,43 I _y = 9,78	11
 P01688	Travessa	0,651	0,301	I _x = 1,63 I _y = 5,95	14
 P01690	Travessa	1,450	0,376	I _x = 3,60 I _y = 69,96	14
 P01692	Travessa	0,696	0,322	I _x = 1,66 I _y = 5,82	13
 P01693	Travessa	1,717	0,478	I _x = 4,42 I _y = 118,5	15

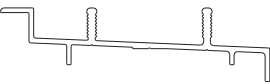
Série de correr CLT85

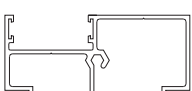
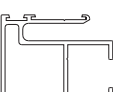
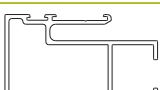
Desenho Referência	Designação	Peso [Kg/m]	Área Trat. [m ² /m]	M. Inércia [cm ⁴]	Pág.
 P01695	Travessa	1,305	0,405	I _x = 3,19 I _y = 44,90	13
 P01752	Soleira	0,820	0,343	I _x = 1,50 I _y = 15,16	18
 P01754	Soleira guilhotina	0,619	0,292	I _x = 0,92 I _y = 12,61	18
 P01755	Prumada 3 folhas	0,881	0,335	I _x = 4,45 I _y = 9,93	11
 P01850	Verga tri-rail	1,082	0,449	I _x = 2,04 I _y = 48,58	20
 P01851	Soleira tri-rail	1,084	0,426	I _x = 1,49 I _y = 50,90	19
 P01852	Ombreira tri-rail	1,035	0,447	I _x = 3,30 I _y = 52,31	17
 P01884	Perfil ligação angular	0,725	0,260	I _x = 1,14 I _y = 33,19	21
 P02340	Ombreira	0,700	0,364	I _x = 2,16 I _y = 15,58	16
 P02413	Verga	0,671	0,326	I _x = 1,25 I _y = 14,10	20



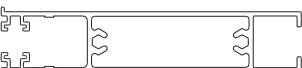

Série de correr CLT85

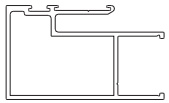
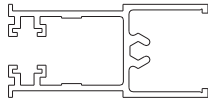
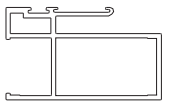
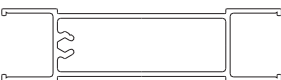
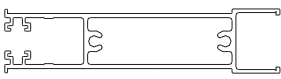
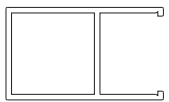
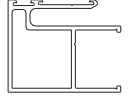
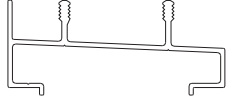
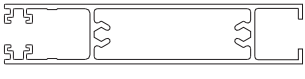
Desenho Referência	Designação	Peso [Kg/m]	Área Trat. [m ² /m]	M. Inércia [cm ⁴]	Pág.
 P02414	Soleira	0,572	0,271	I _x = 0,44 I _y = 11,90	18
 P02415	Soleira	0,673	0,320	I _x = 1,18 I _y = 15,41	18
 P02416	Ombreira	0,761	0,390	I _x = 2,45 I _y = 16,03	17
 P02417	Prumada	0,664	0,256	I _x = 3,22 I _y = 3,83	11
 P02418	Prumada	0,771	0,283	I _x = 4,12 I _y = 9,12	12
 P02419	Prumada	0,495	0,178	I _x = 1,62 I _y = 3,06	10
 P02420	Prumada	0,608	0,209	I _x = 2,16 I _y = 7,23	10
 P02421	Travessa	0,959	0,314	I _x = 2,51 I _y = 26,52	14
 P02422	Travessa	0,640	0,342	I _x = 1,52 I _y = 5,25	14
 P02423	Travessa	1,172	0,416	I _x = 2,89 I _y = 40,34	13

Série de correr CLT85

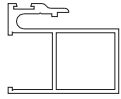
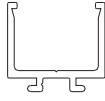
Desenho Referência	Designação	Peso [Kg/m]	Área Trat. [m ² /m]	M. Inércia [cm ⁴]	Pág.
 P02440	Prumada	0,574	0,192	I _x = 2,06 I _y = 6,25	10
 P02441	Prumada	0,746	0,263	I _x = 4,23 I _y = 7,46	12
 P02442	Travessa	0,643	0,335	I _x = 1,77 I _y = 4,92	13
 P02443	Prumada 3 folhas	0,784	0,262	I _x = 4,37 I _y = 9,46	12
 P02536	Travessa	0,935	0,297	I _x = 2,90 I _y = 23,90	14
 P02537	Travessa	1,164	0,399	I _x = 3,06 I _y = 38,79	15
 P02538	Prumada	0,460	0,161	I _x = 1,55 I _y = 2,51	10
 P02539	Prumada	0,631	0,243	I _x = 3,12 I _y = 3,20	12
 P02833	Soleira	0,735	0,341	I _x = 1,75 I _y = 16,59	18
 P02999	Travessa	1,177	0,401	I _x = 2,89 I _y = 40,24	13

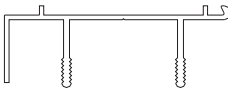
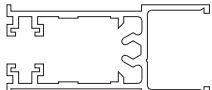
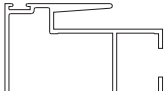
Série de correr CLT85

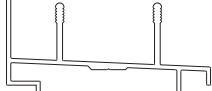
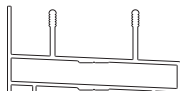
Desenho Referência	Designação	Peso [Kg/m]	Área Trat. [m ² /m]	M. Inércia [cm ⁴]	Pág.
 P03027	Prumada 3 folhas	0,662	0,226	I _x = 3,16 I _y = 3,95	12
 P03241	Postiço vidro duplo	0,302	0,139	I _x = -- I _y = --	21
 P03434	Soleira janela dupla	1,775	0,618	I _x = 3,96 I _y = 171,3	19
 P03435	Ombreira janela dupla	1,387	0,677	I _x = 2,48 I _y = 122,3	17
 P03436	Verga janela dupla	0,593	0,289	I _x = 1,12 I _y = 10,22	20
 P03586	Travessa	0,662	0,343	I _x = 1,84 I _y = 5,74	13
 P04146	Prumada	0,823	0,276	I _x = 4,46 I _y = 8,70	12
 P04186	Ombreira	0,657	0,366	I _x = 2,04 I _y = 14,65	16
 P06140	Soleira	0,794	0,345	I _x = 1,95 I _y = 15,18	18
 P06141	Soleira	1,073	0,326	I _x = 3,98 I _y = 20,68	19

NOTA: Os momentos de inércia aqui apresentados são calculados com base no eixo

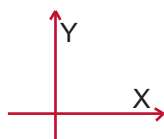

com a posição dos perfis indicada neste índice.

Série de correr CLT85

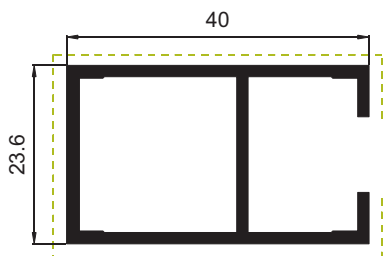

P01682 Prumada lateral

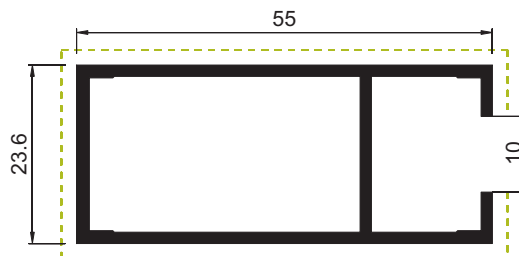

P01686 Prumada lateral

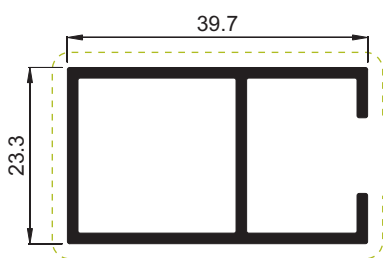

P02419 Prumada lateral

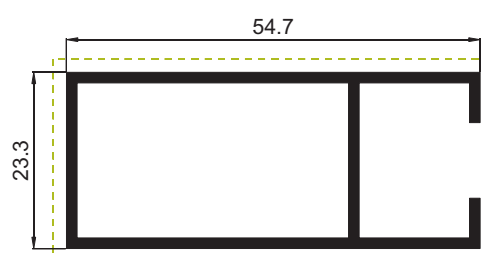

P02420 Prumada lateral

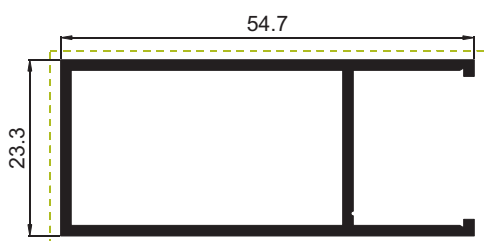

P02440 Prumada lateral

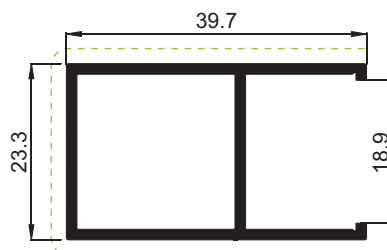

P02538 Prumada lateral

Série de correr CLT85

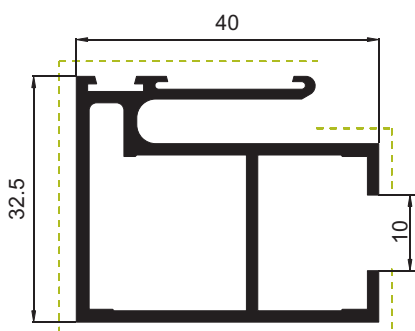

P01683 Prumada central

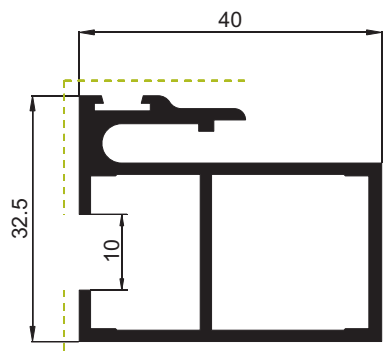

P01684 Prumada 3 folhas

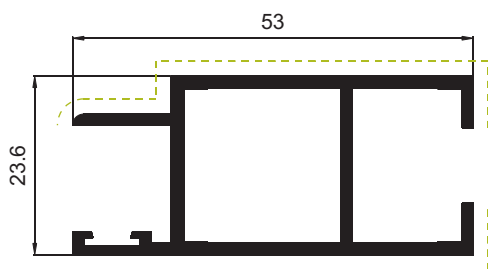

P01685 Prumada 4 folhas

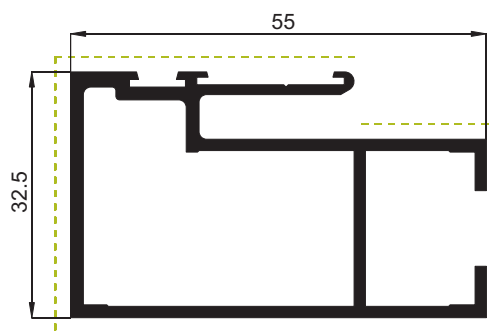

P01687 Prumada central

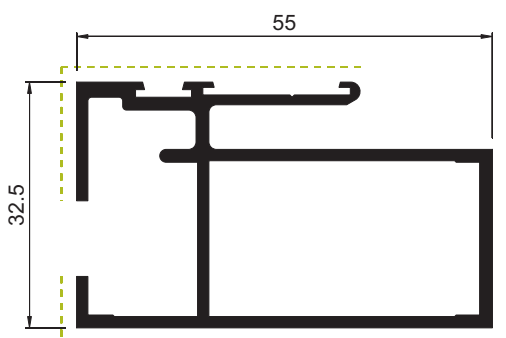

P01755 Prumada 3 folhas

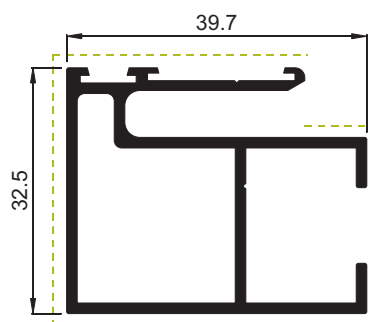

P02417 Prumada central

Série de correr CLT85

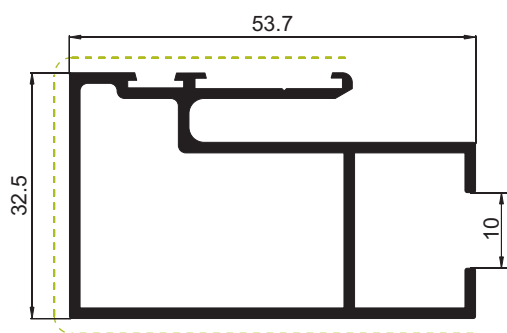

P02418 Prumada central

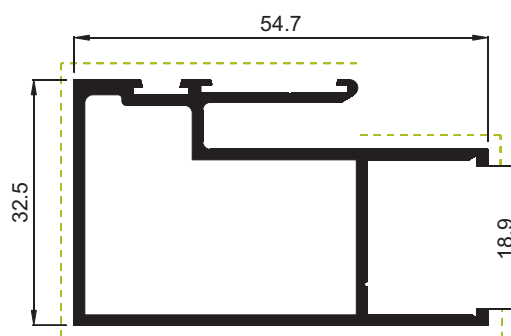

P02441 Prumada central

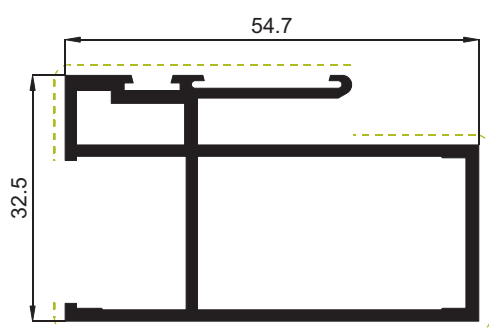

P02443 Prumada 3 folhas

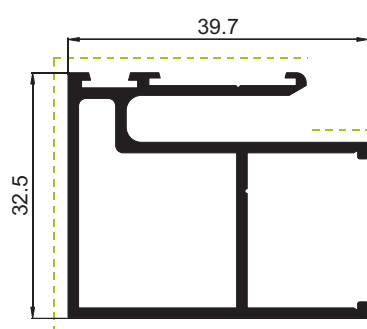

P02539 Prumada central

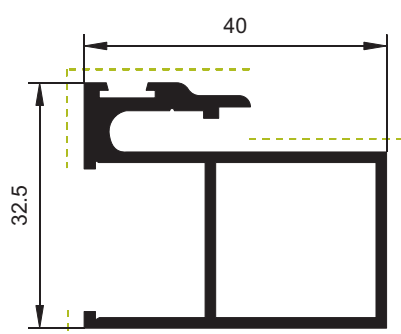

P03027 Prumada 3 folhas

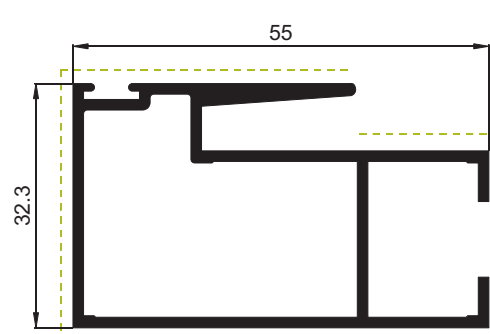

P04146 Prumada central

Série de correr CLT85

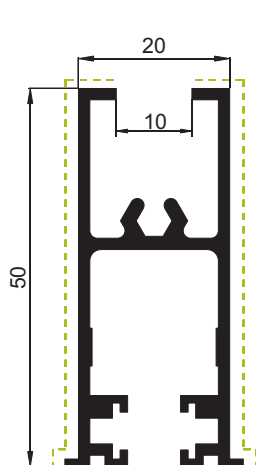

P01692 Travessa

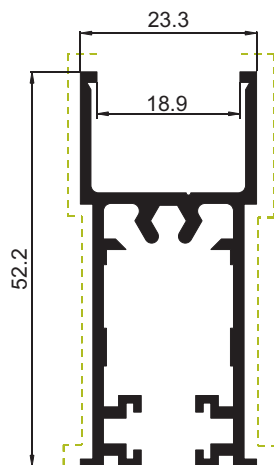

P03586 Travessa

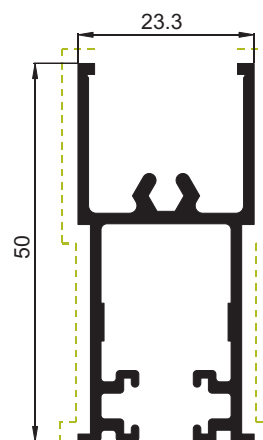

P02442 Travessa

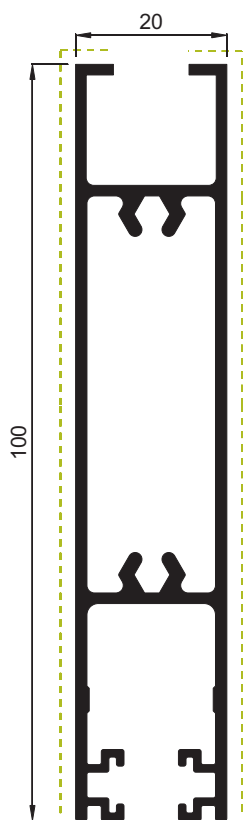

P02999 Travessa

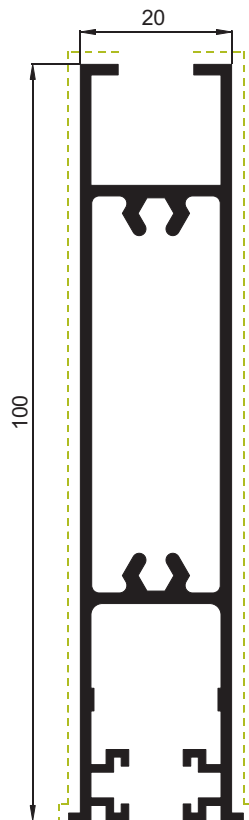

P02423 Travessa

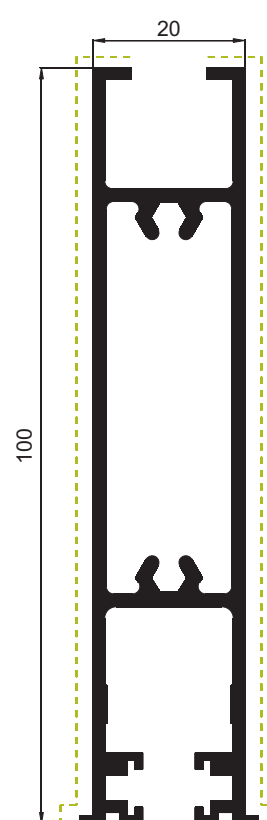

P01695 Travessa

Série de correr CLT85

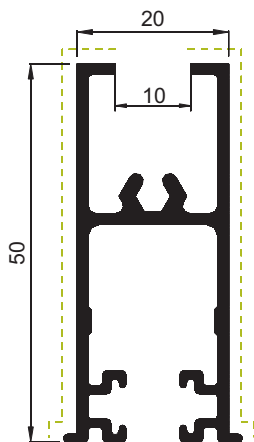

P02422

Travessa

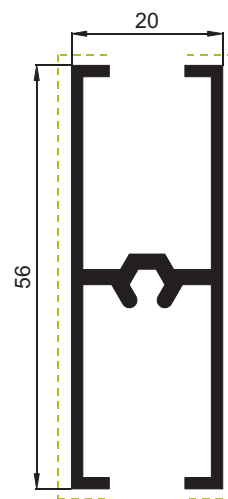

P01688

Travessa

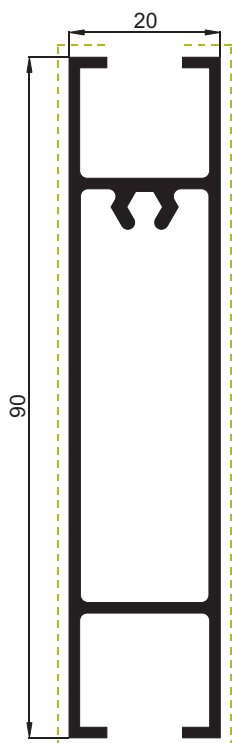

P02421

Travessa

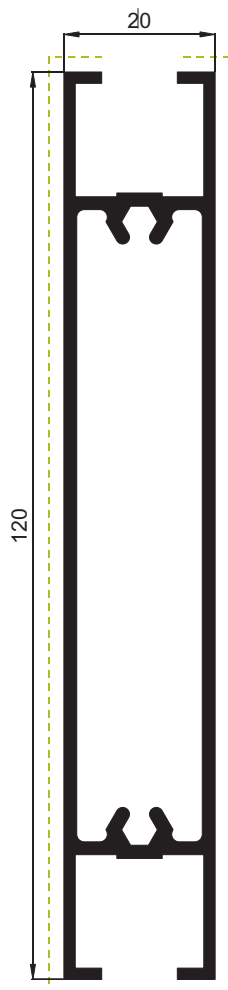

P01690

Travessa

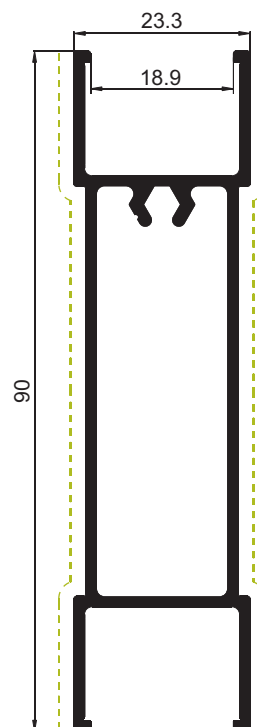

P02536

Travessa

Série de correr CLT85

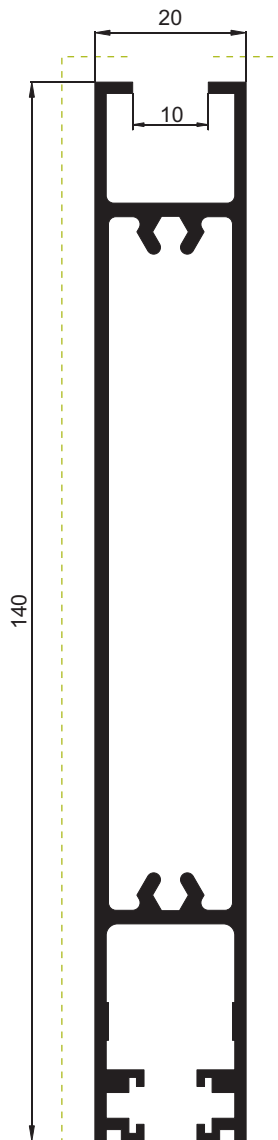

P01693

Travessa

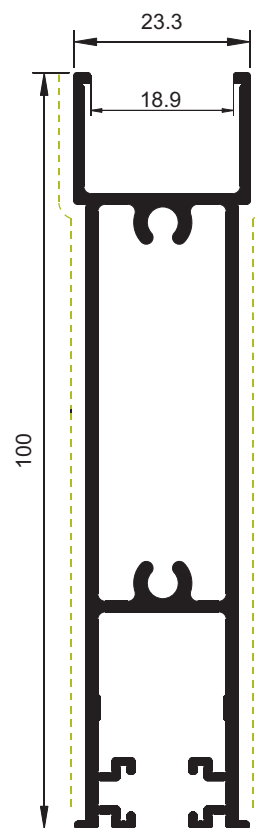

P02537

Travessa

Série de correr CLT85

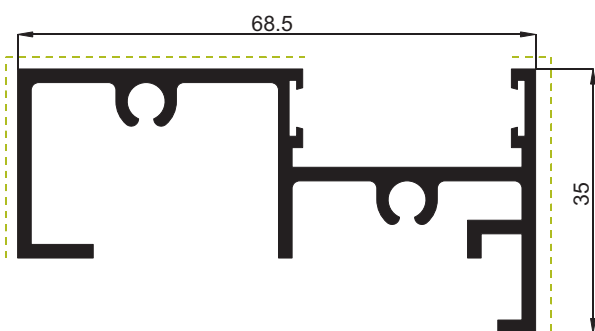

P00675 Ombreira

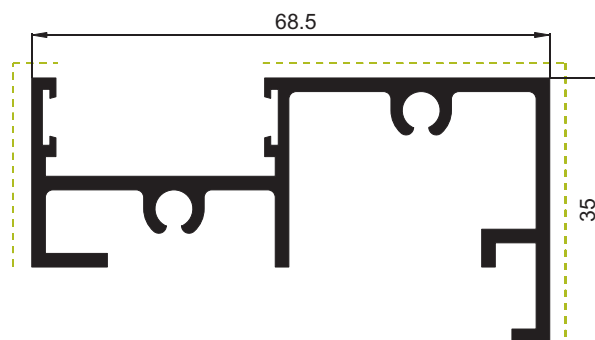

P00676 Ombreira

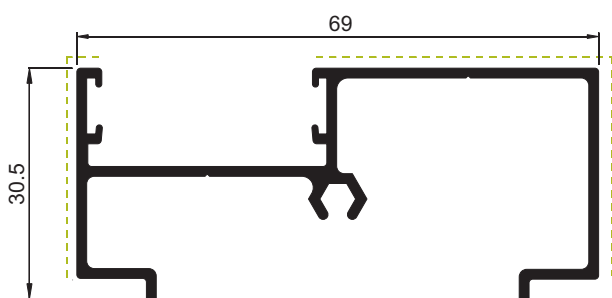

P04186 Ombreira

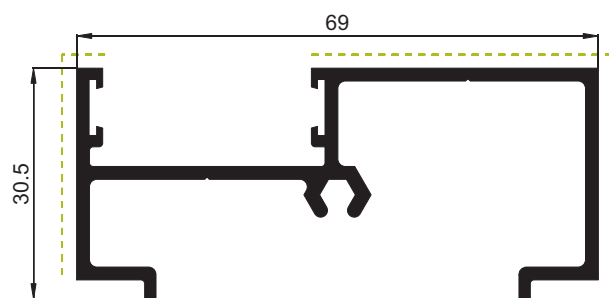

P01680 Ombreira

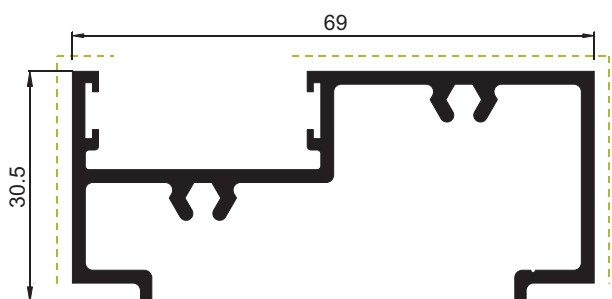

P01681 Ombreira

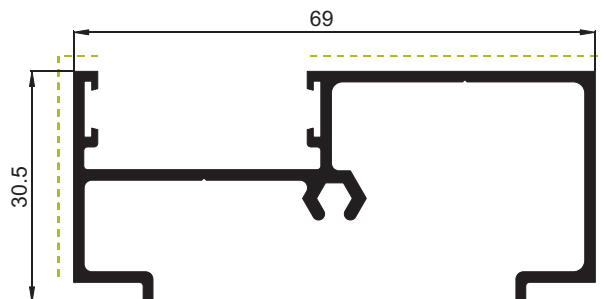

P02340 Ombreira

Série de correr CLT85

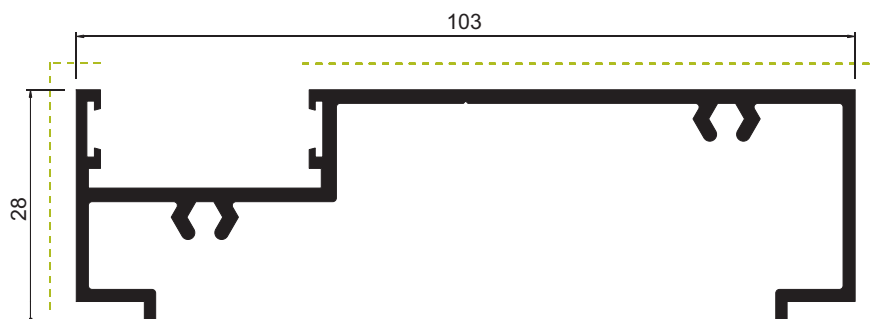

P01852 Ombreira tri-rail

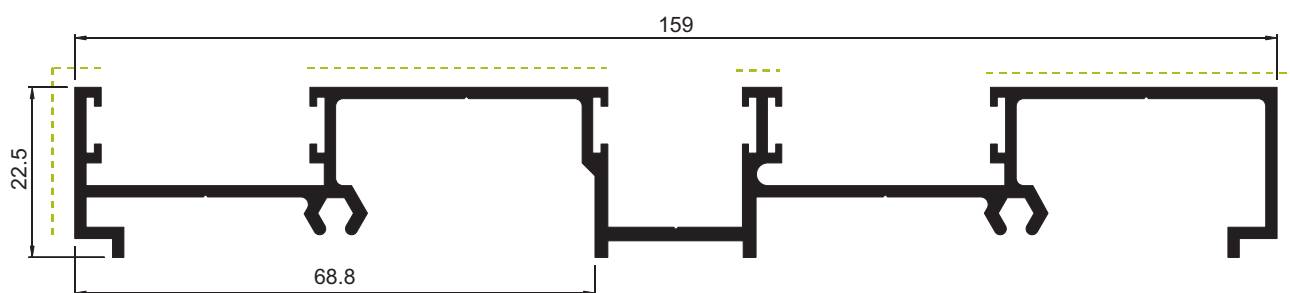

P03435 Ombreira janela dupla

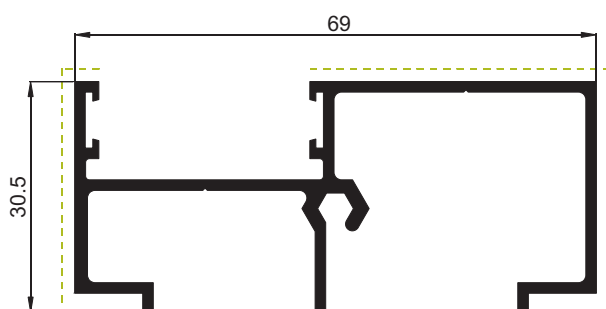

P02416 Ombreira

Série de correr CLT85

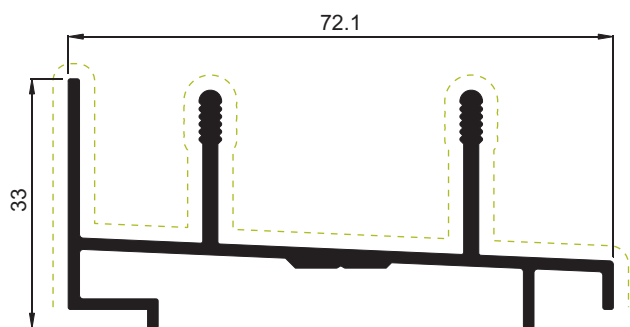

P06140 Soleira

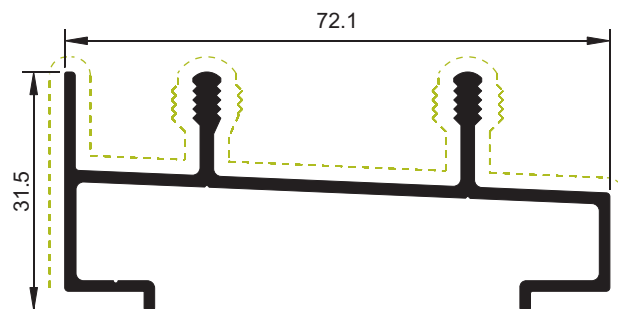

P02833 Soleira

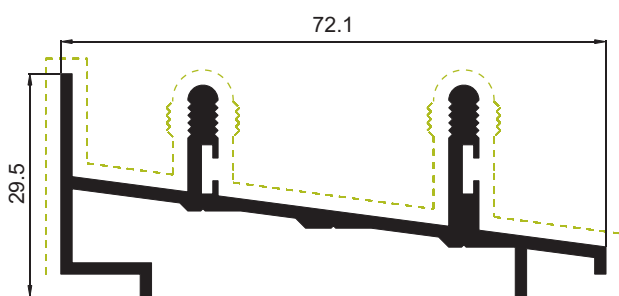

P01752 Soleira

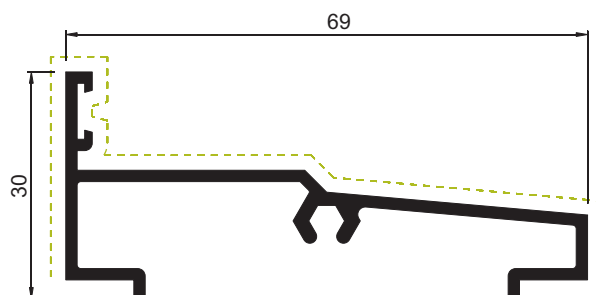

P01754 Soleira guilhotina

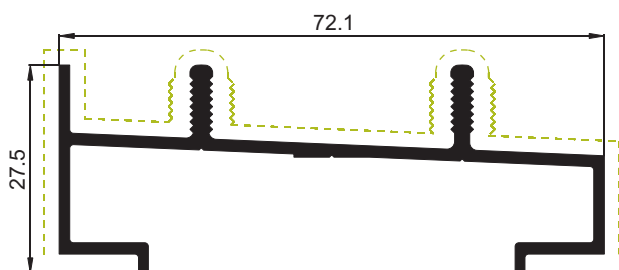

P02415 Soleira

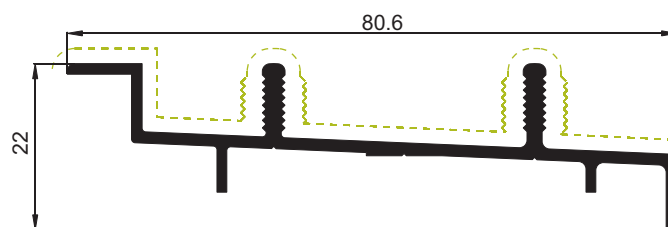

P02414 Soleira

Série de correr CLT85

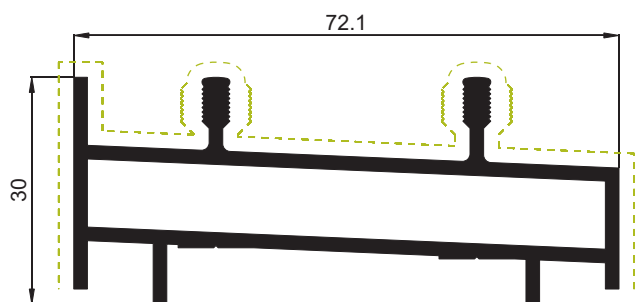

P00232

Soleira

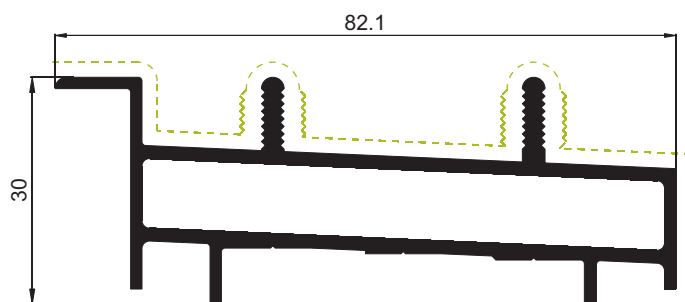

P01679

Soleira

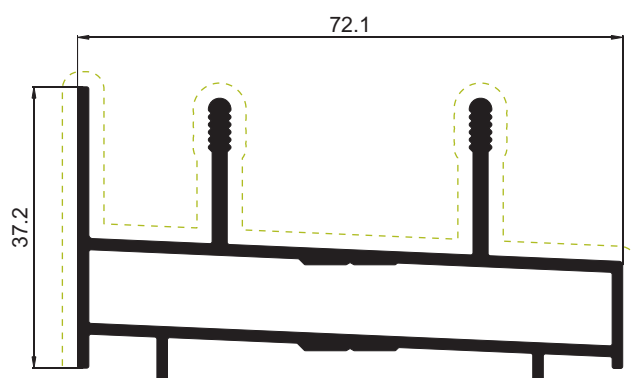

P06141

Soleira

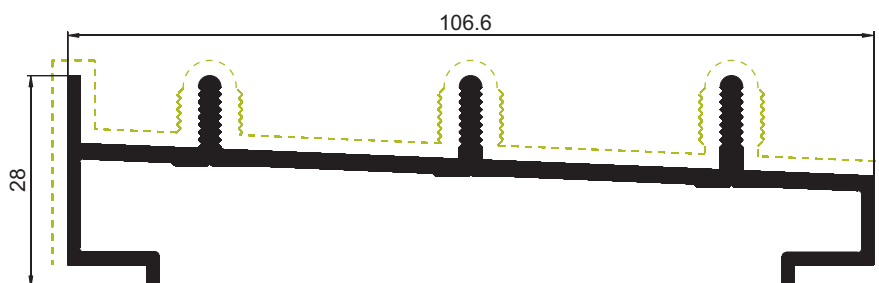

P01851

Soleira tri-rail

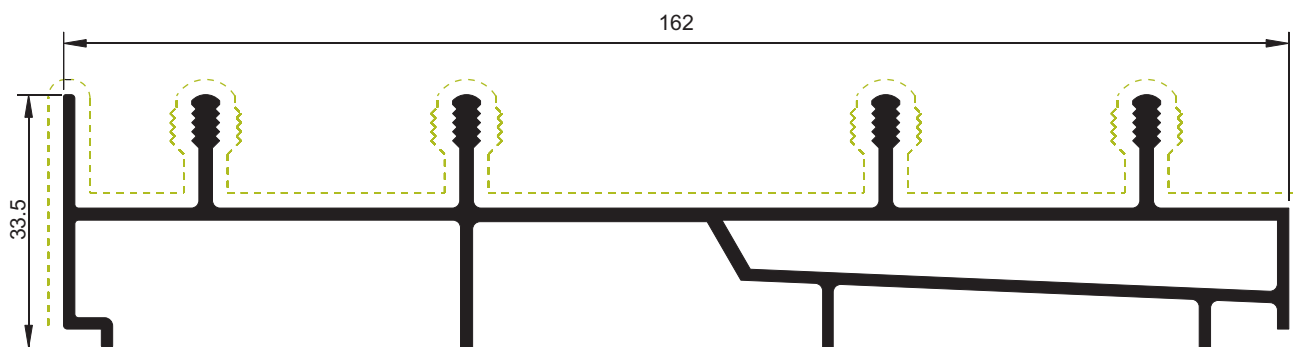

P03434

Soleira janela dupla

Série de correr CLT85

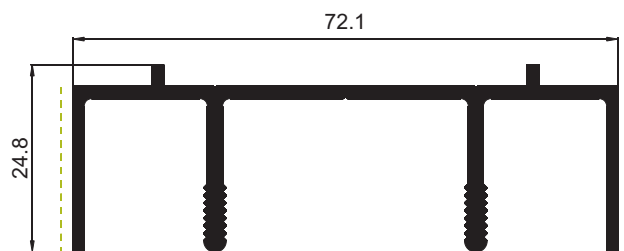

P01677 Verga

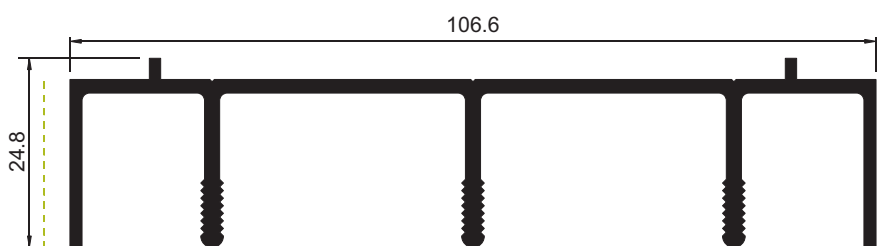

P01850 Verga tri-rail

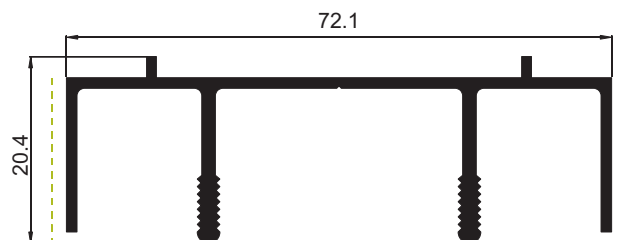

P02413 Verga

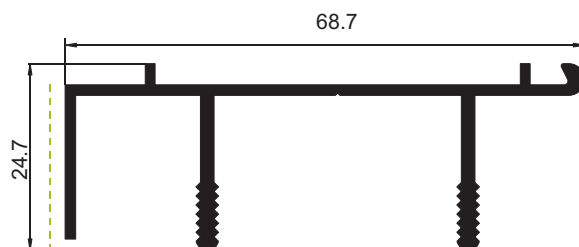

P03436 Verga janela dupla

Série de correr CLT85

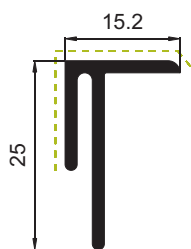

P01641 Remate

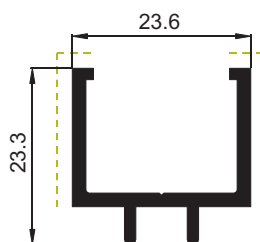

P01665 Postiço vidro duplo



P01673 Perfil de ligação

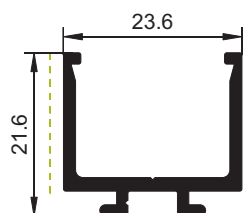

P03241 Postiço vidro duplo

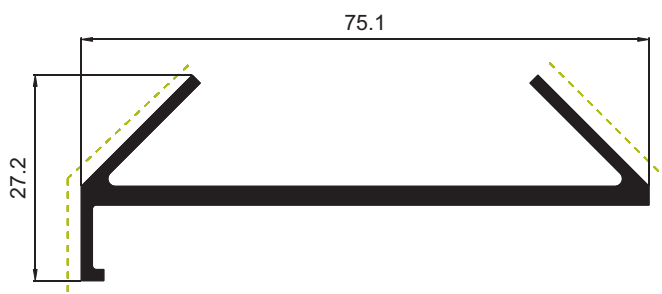

P01884 Perfil de ligação angular

Série de correr CLT85

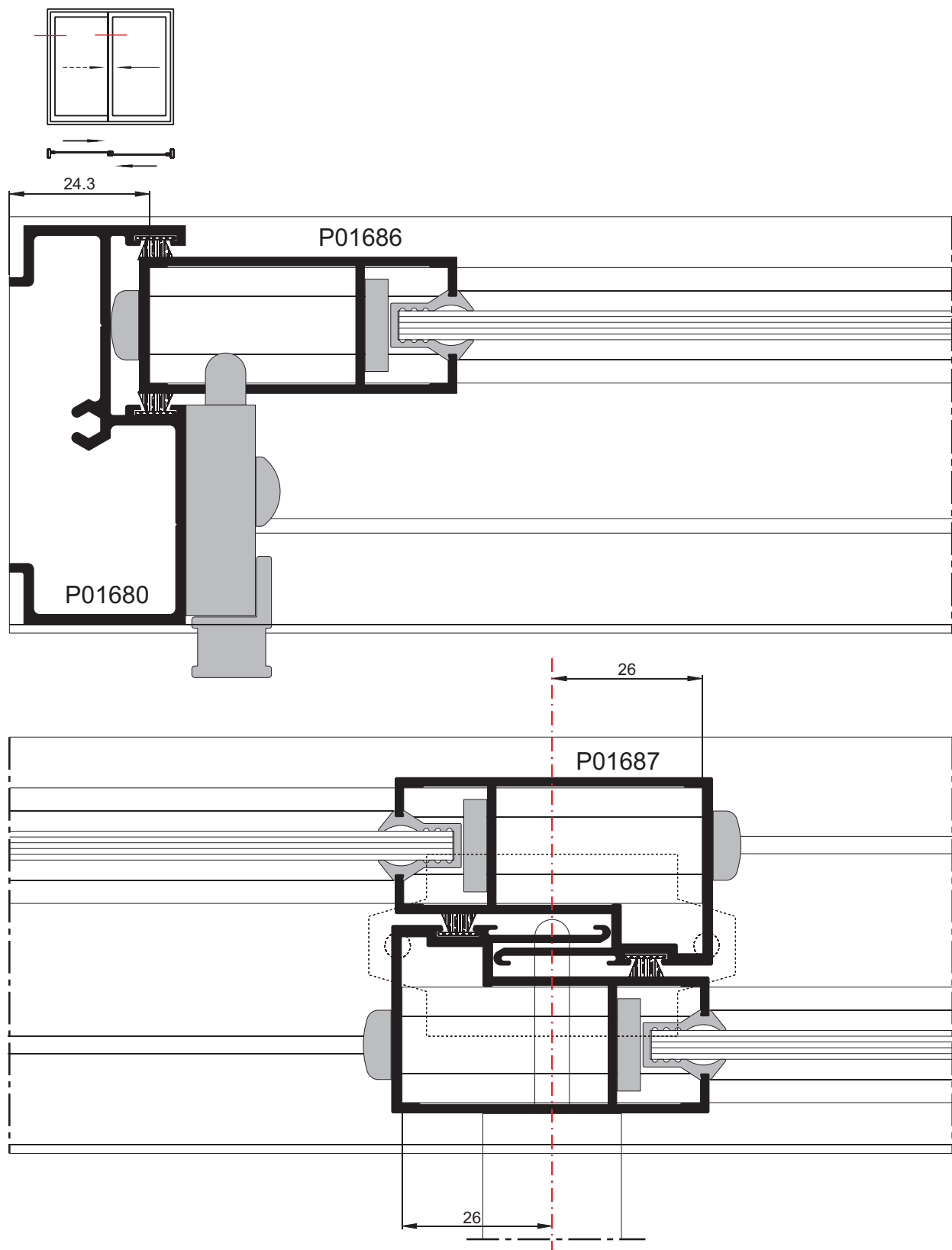

Série de correr CLT85

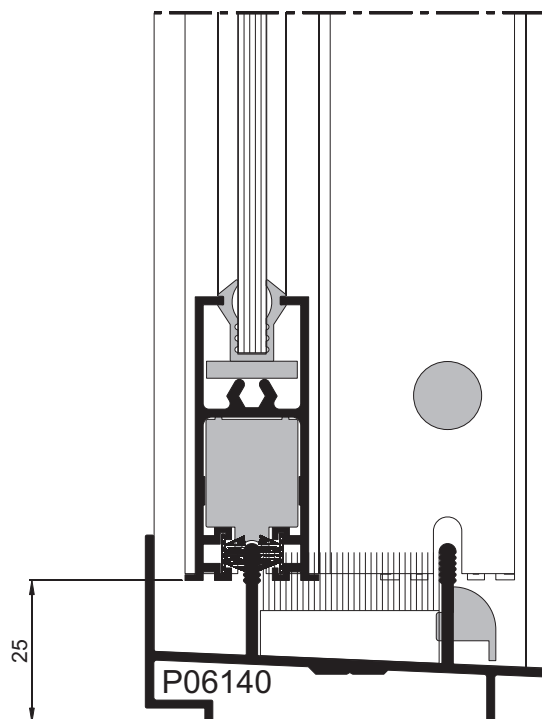
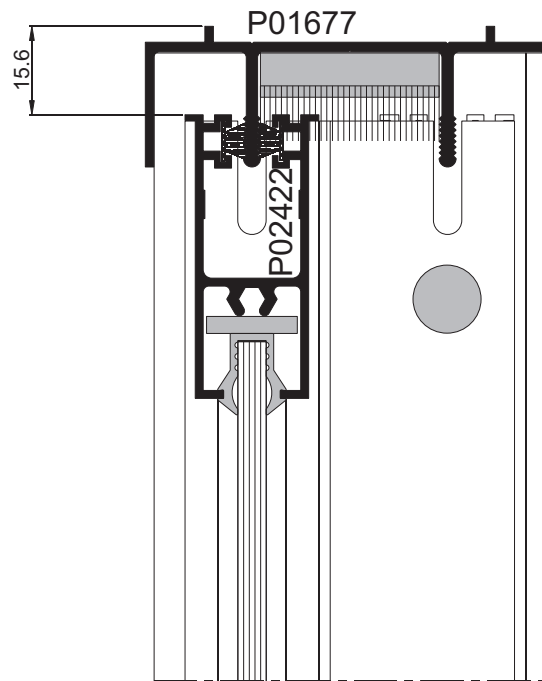
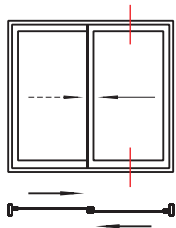

Interior

Exterior

Sem escala

Série de correr CLT85

Representação	Designação	Referência	Contactos	Notas
	Placa de vedação	SK	POLISMAR, Lda. Mário Rodrigues Tel: 219 217 729 Fax: 219 201 410 mariorodrigues@polismar.pt	Conjunto
	Rolamento	915	POLISMAR, Lda. Mário Rodrigues Tel: 219 217 729 Fax: 219 201 410 mariorodrigues@polismar.pt	
	Goteira	9001	POLISMAR, Lda. Mário Rodrigues Tel: 219 217 729 Fax: 219 201 410 mariorodrigues@polismar.pt	
	Fecho central	220H	ALUALPHA, S.A. Rui Ribeiro Tel: 219 612 434 Fax: 219 615 902 info@alualpha.pt	
	Fecho lateral	901PL	POLISMAR, Lda. Mário Rodrigues Tel: 219 217 729 Fax: 219 201 410 mariorodrigues@polismar.pt	
	Tampa parafuso	1174	POLISMAR, Lda. Mário Rodrigues Tel: 219 217 729 Fax: 219 201 410 mariorodrigues@polismar.pt	
	Calço do vidro	5012	POLISMAR, Lda. Mário Rodrigues Tel: 219 217 729 Fax: 219 201 410 mariorodrigues@polismar.pt	
	Vedante vidro simples 5 a 6 mm	P1163-100-E1	PERVEDANT Tel: 244 830 650 Fax: 244 830 659 info@pervedant.com	Vedante em "U"
	Pelúcia	6.9x4.5 mm Stop-Fin	Mercado	
	Silicone	0892-210 2	Wurth	

- 1 - Lintel, padieira ou verga
- 2 - Bandeira
- 3 - Travessa superior
- 4 - Travessa intermédia
- 5 - Folha de janela ou porta
- 6 - Couceira
- 7 - Tábua de peito, tábua de soleira, soleira
- 8 - Travessa superior da folha
- 9 - Couceira da folha
- 10 - Travessa inferior da folha
- 11 - Montante
- 12 - Tábua de peito/soleira
- 13 - Pinázio

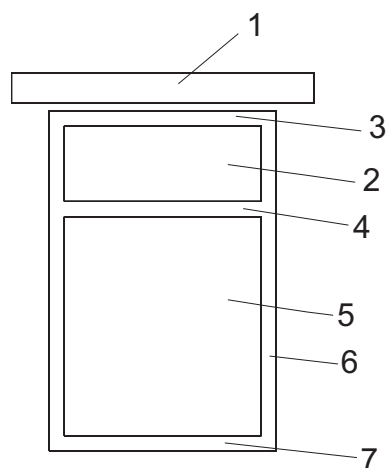
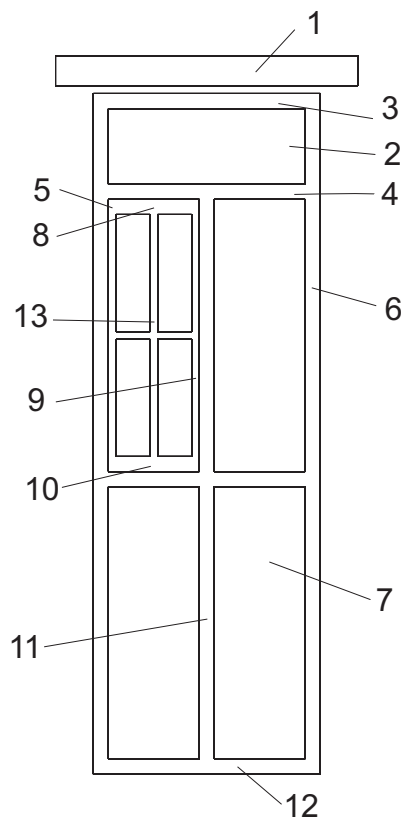

Designações das componente de janelas e portas de acordo com a NP EN 12519 de 2008.

Este catálogo poderá ser sujeito a alterações por motivos técnicos, sem aviso prévio.
Qualquer encomenda deverá ser sujeita a confirmação com os nossos serviços.

Hydro Alumínio Portalex, S.A.

Sede:

Estrada de São Marcos. 23
2735-521 CACÉM - PORTUGAL

Tel.: (+351) 21 041 25 00

Fax: (+351) 21 041 25 28

Fax Comercial: (+351) 21 041 25 07

Actividades de Valor Acrescentado:

Lugar de São Carlos
2726-901 MEM-MARTINS - PORTUGAL

Tel.: (+351) 21 041 24 00

Fax: (+351) 21 921 66 21

CONTRIBUINTE Nº 500 396 361
REG. COMERCIAL DE SINTRA Nº: 1709
CAPITAL SOCIAL 1.483.850,00 €
www.hydro.com/extrusion/portugal



HYDRO