

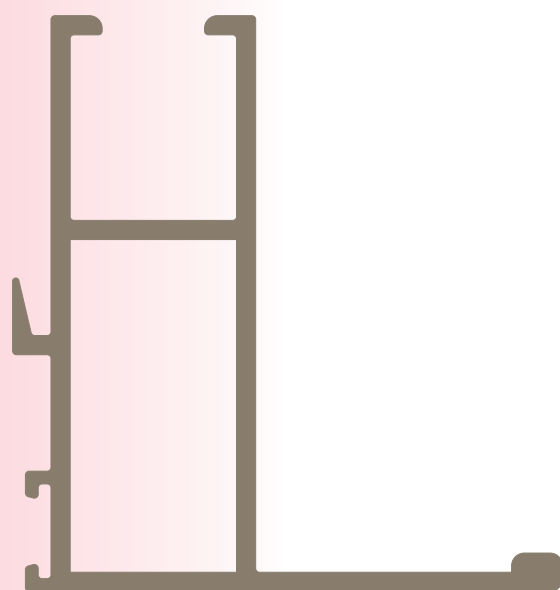

CAT 00

SÉRIE DE CORRER MINI

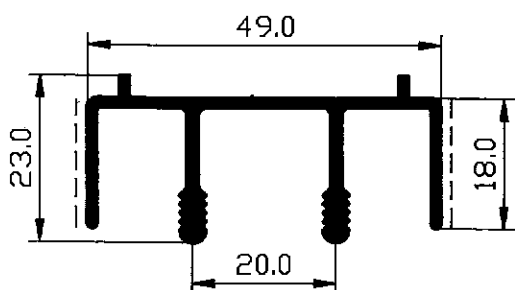



PQR-3033

PESO TEORICO 0.524 Kg/m
 AREA A ANODIZAR 0.261 m/m

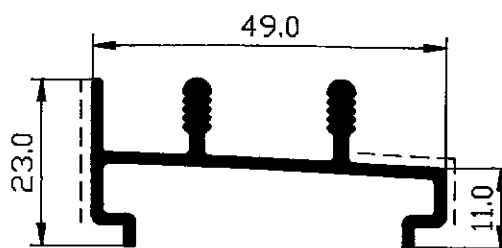

PQR-3034

PESO TEORICO 0.460 Kg/m
 AREA A ANODIZAR 0.230 m/m

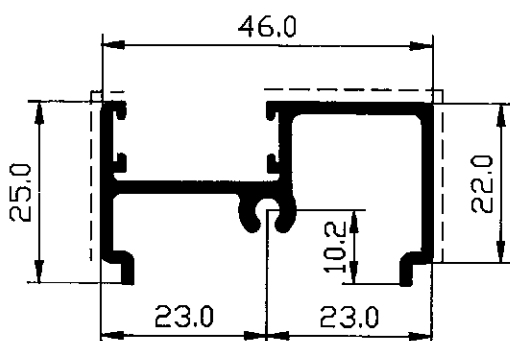

PQR-3035

PESO TEORICO 0.472 Kg/m
 AREA A ANODIZAR 0.258 m/m

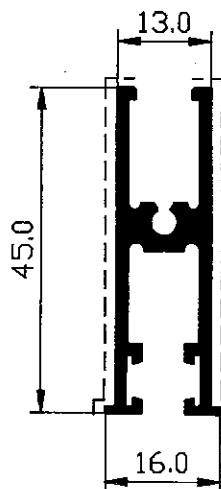

PQR-3036

PESO TEORICO 0.500 Kg/m
 AREA A ANODIZAR 0.243 m/m

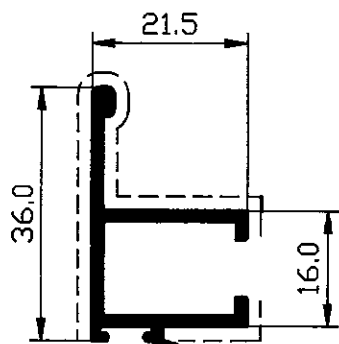

PQR-3037

PESO TEORICO 0.338 Kg/m
 AREA A ANODIZAR 0.177 m/m

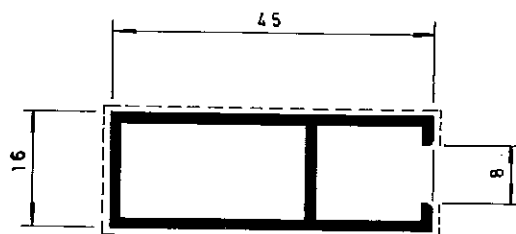

POR-1062
0,493 kg/m
0,164 m²/m área a anodizar
0,114 m²/m área a polir

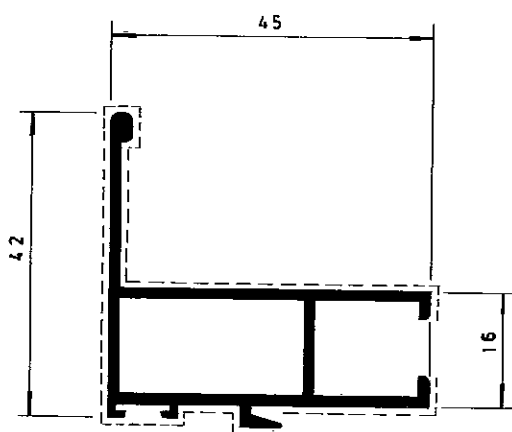

POR-1063
0,665 kg/m
0,250 m²/m área a anodizar
0,167 m²/m área a polir

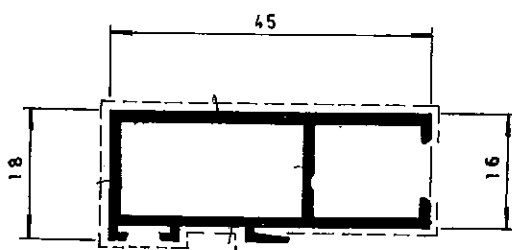

POR-1638
0,532 kg/m
0,190 m²/m área a anodizar
0,116 m²/m área a polir

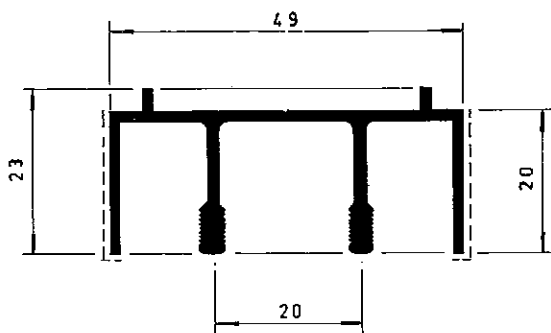

POR-847
 0,622 kg/m
 0,263 m²/m área a anodizar
 0,043 m²/m área a polir

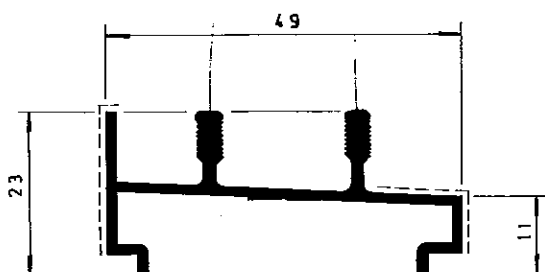

POR-846
 0,542 kg/m
 0,224 m²/m área a anodizar
 0,043 m²/m área a polir

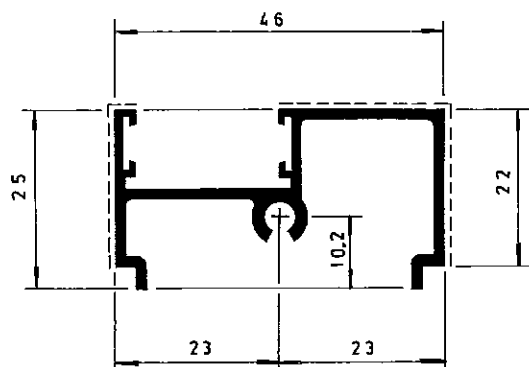

POR-848
 0,521 kg/m
 0,262 m²/m área a anodizar
 0,070 m²/m área a polir

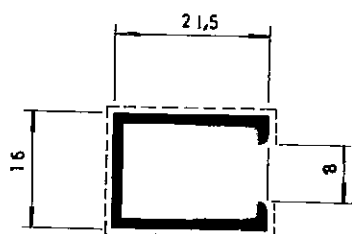

POR-850

0,232 kg/m
 0,124 m²/m área a anodizar
 0,067 m²/m área a polir

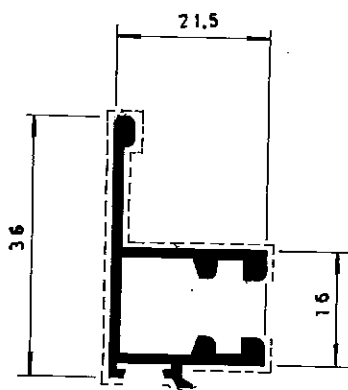

POR-851

0,404 kg/m
 0,188 m²/m área a anodizar
 0,108 m²/m área a polir

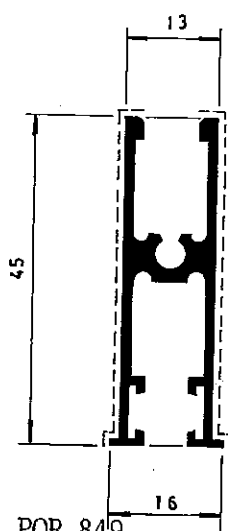

POR-849

0,525 kg/m
 0,239 m²/m área a anodizar
 0,098 m²/m área a polir

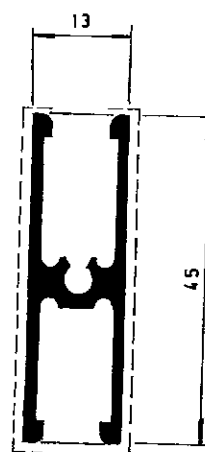

POR-1640

0,511 kg/m
 0,218 m²/m área a anodizar
 0,100 m²/m área a polir

DIVULGAÇÃO

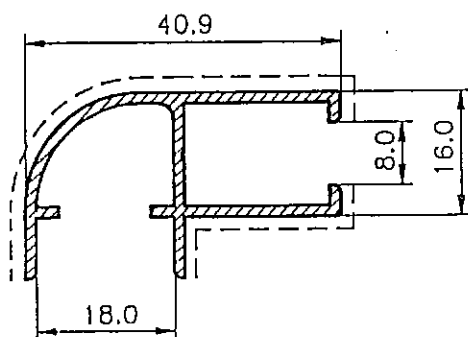

POR-3328
0.420 Kg/m
0.223 m AREA A ANODIZAR

Este catálogo poderá ser sujeito a alterações por motivos técnicos, sem aviso prévio.
Qualquer encomenda deverá ser sujeita a confirmação com os nossos serviços.

H A Portalex

SEDE: Estr. S. Marcos, 23 – 2735-521 Cacém
PORTUGAL
Telef.: (+351) 21 041 25 00
Fax: (+351) 21 041 25 28
Fax Dir. Comercial: (+351) 21 041 25 07

AVA: Lugar de S. Carlos
2726-901 Mem Martins
PORTUGAL
Telef.: (+351) 21 041 24 00
Fax: (+351) 21 041 24 29

Contribuinte nº 500396361
Registo Comercial de Sintra nº 1709
Capital Social: EUR 1.483.850,00
www.hydro.com/extrusion/portugal