

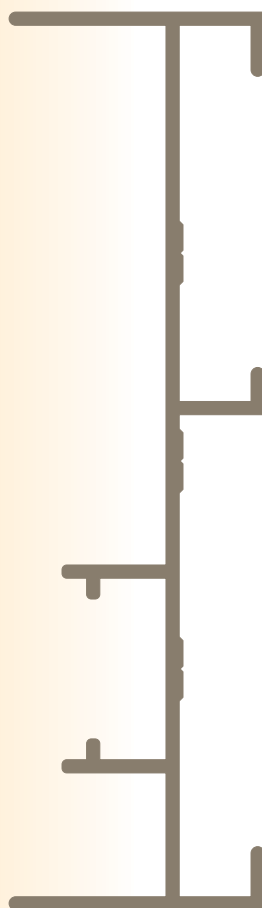

CAT 10

# *SÉRIE DE CORRER P3*

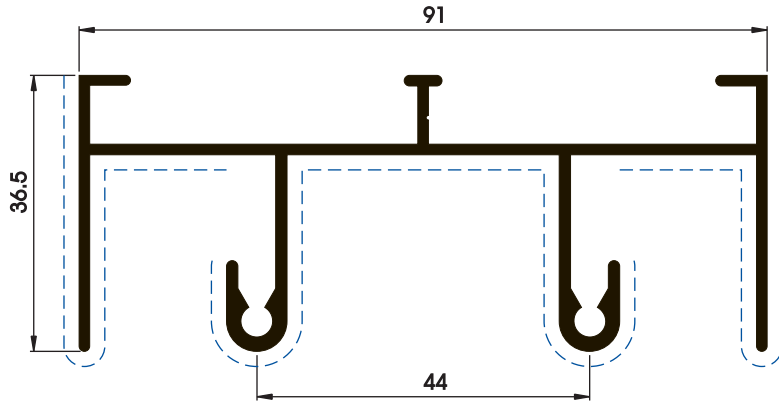



**P03866**

1,059 kg/m  
0,530 m<sup>2</sup>/m

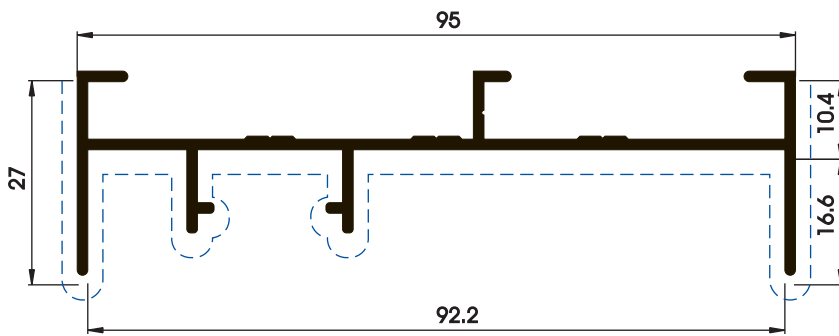

**P03867**

0,756 kg/m  
0,392 m<sup>2</sup>/m

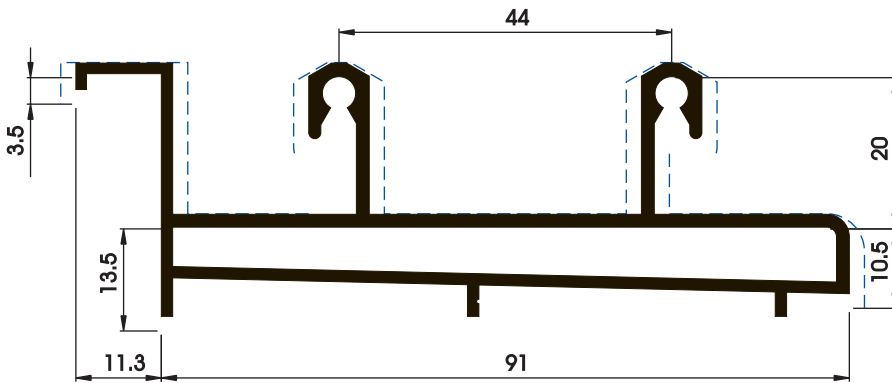

**P03868**

1,342 kg/m  
0,497 m<sup>2</sup>/m

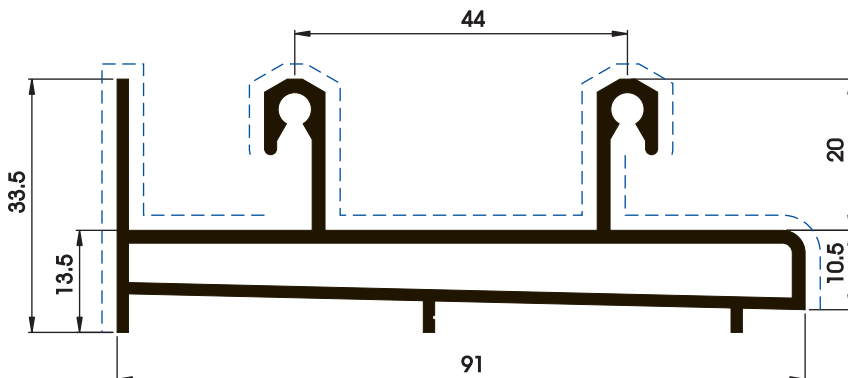

**P04166**

1,293 kg/m  
0,395 m<sup>2</sup>/m

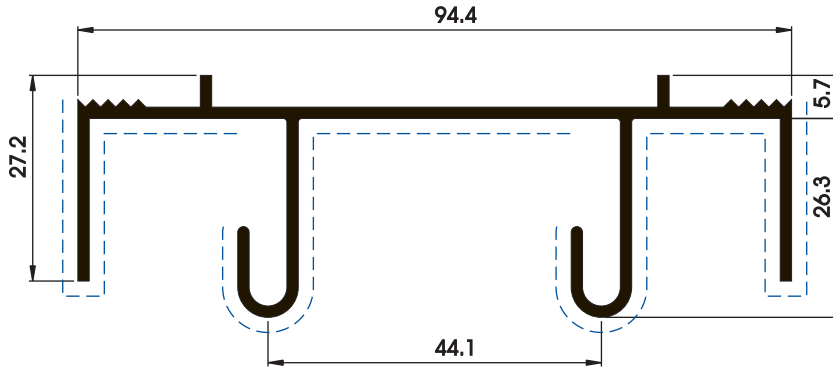

**P03076**

0,940 kg/m  
0,465 m<sup>2</sup>/m

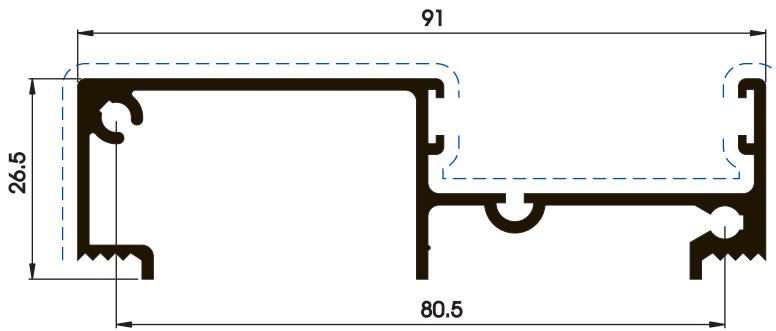

**P03078**

0,935 kg/m  
0,420 m<sup>2</sup>/m

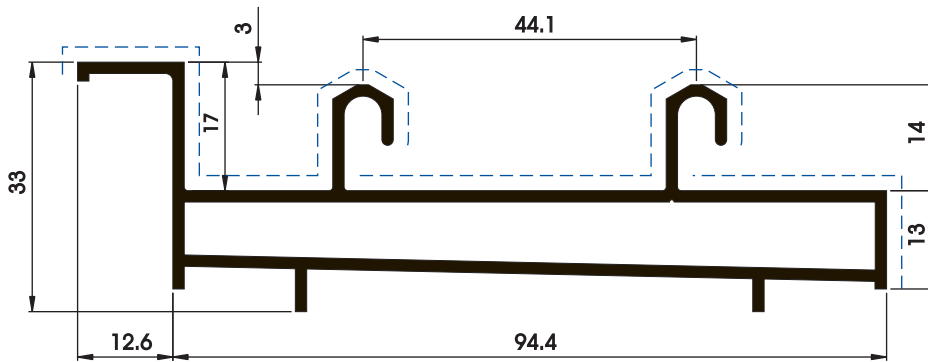

**P03077**

1,210 kg/m  
0,397 m<sup>2</sup>/m

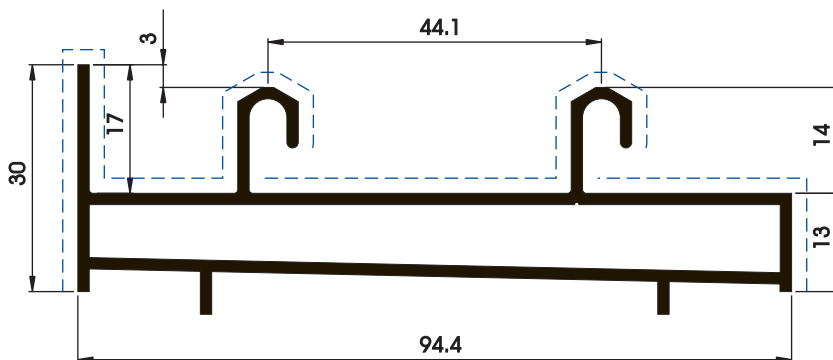

**P03203**

1,155 kg/m  
0,369 m<sup>2</sup>/m

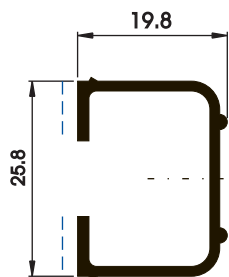

**P04190**  
0,269 kg/m      0,147 m<sup>2</sup>/m

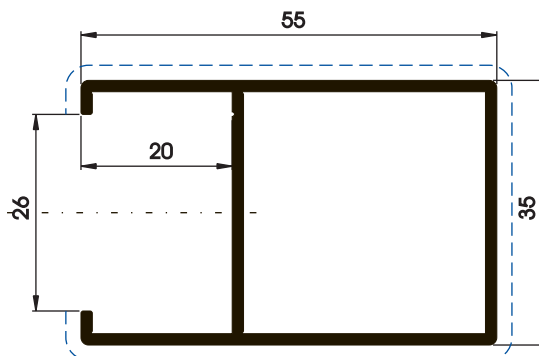

**P03268**  
0,727 kg/m      0,232 m<sup>2</sup>/m

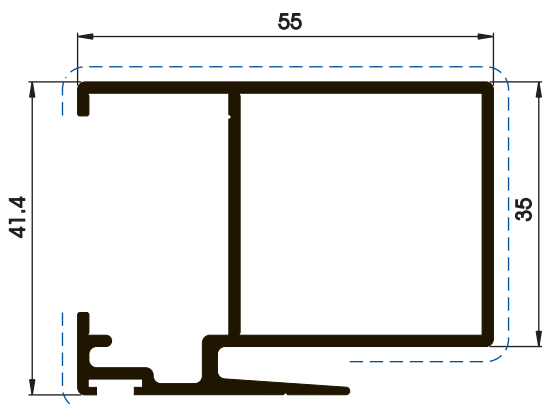

**P03270**  
0,886 kg/m      0,300 m<sup>2</sup>/m

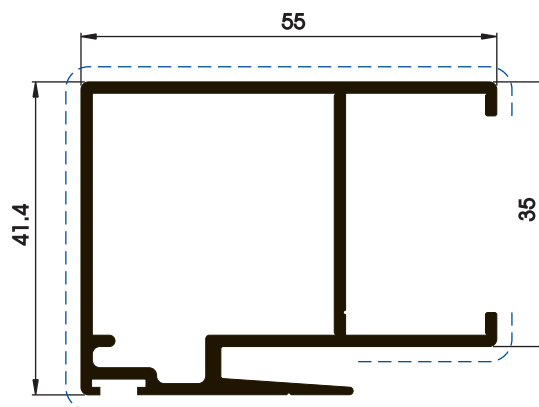

**P03269**  
0,884 kg/m      0,283 m<sup>2</sup>/m

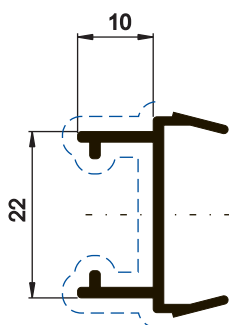

**P04180**  
0,251 kg/m  
0,140 m<sup>2</sup>/m

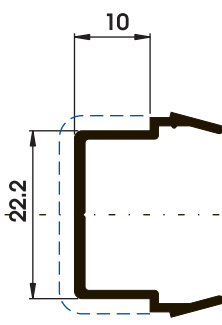

**P03871**  
0,207 kg/m  
0,127 m<sup>2</sup>/m

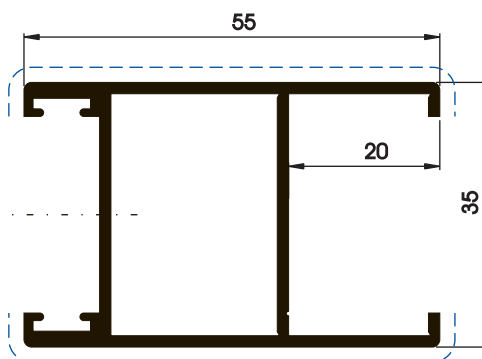

**P03870**  
0,803 kg/m      0,271 m<sup>2</sup>/m

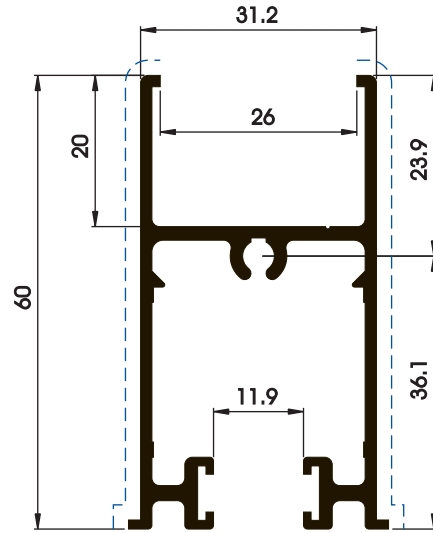

**P03271**  
 0,886 kg/m  
 0,406 m<sup>2</sup>/m

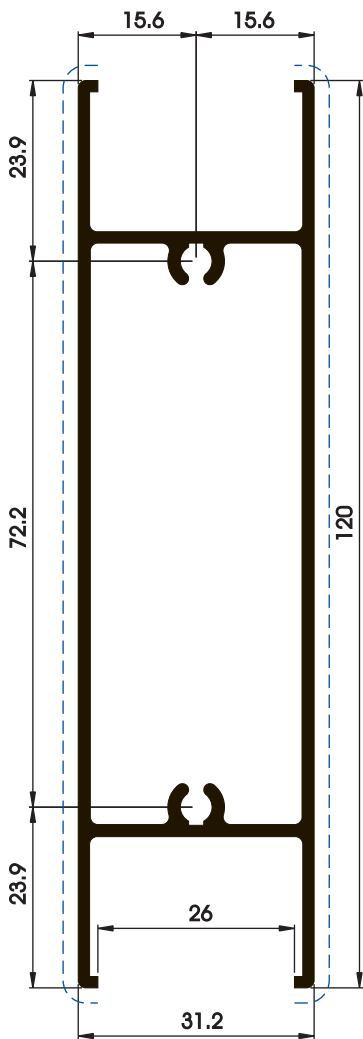

**P03272**  
 1,380 kg/m  
 0,388 m<sup>2</sup>/m

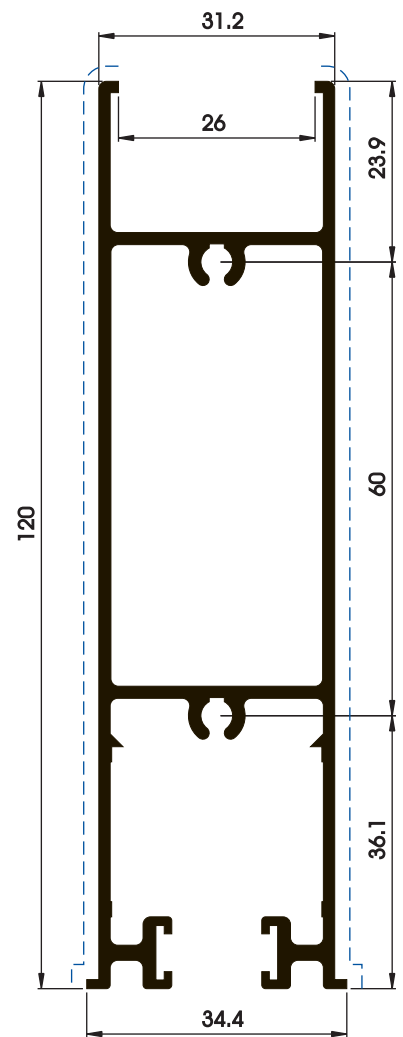

**P03273**  
 1,566 kg/m  
 0,527 m<sup>2</sup>/m

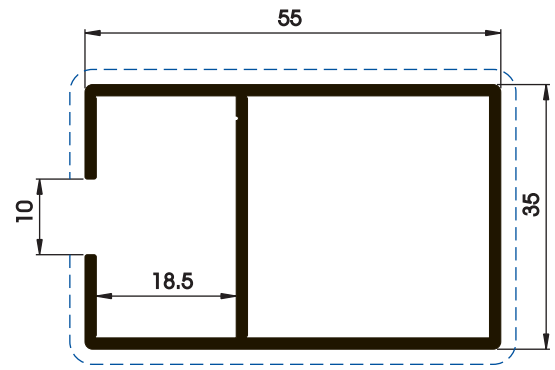

**P03497**  
0,791 kg/m      0,263 m<sup>2</sup>/m

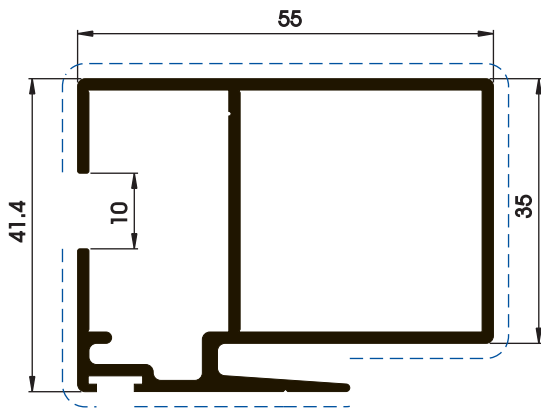

**P03499**  
0,952 kg/m      0,332 m<sup>2</sup>/m

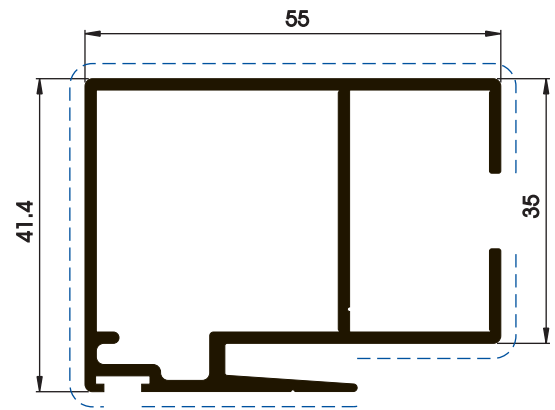

**P03498**  
0,950 kg/m      0,317 m<sup>2</sup>/m

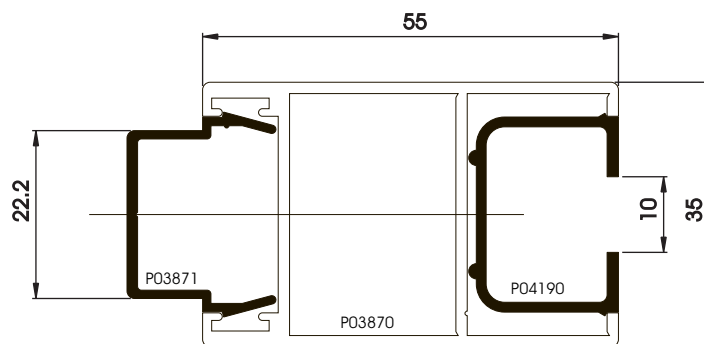

Montagem

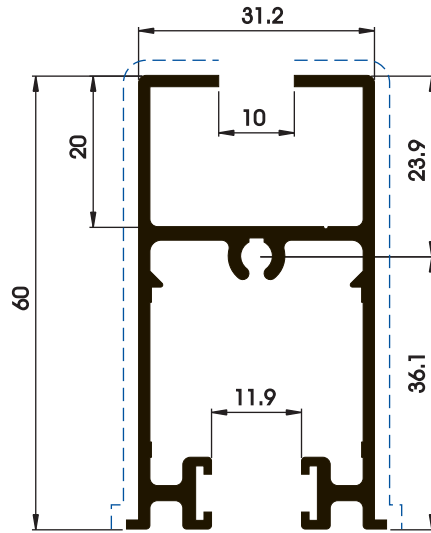

**P03500**  
 0,951 kg/m  
 0,438 m<sup>2</sup>/m

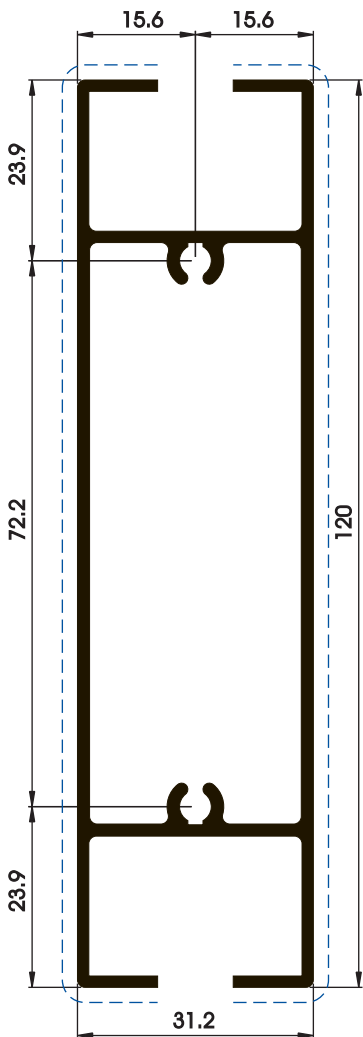

**P03501**  
 1,466 kg/m  
 0,420 m<sup>2</sup>/m

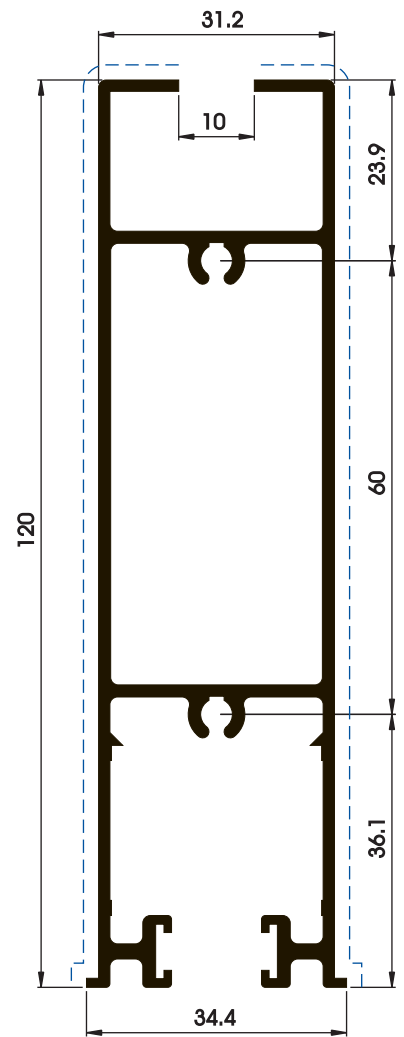

**P03502**  
 1,631 kg/m  
 0,559 m<sup>2</sup>/m

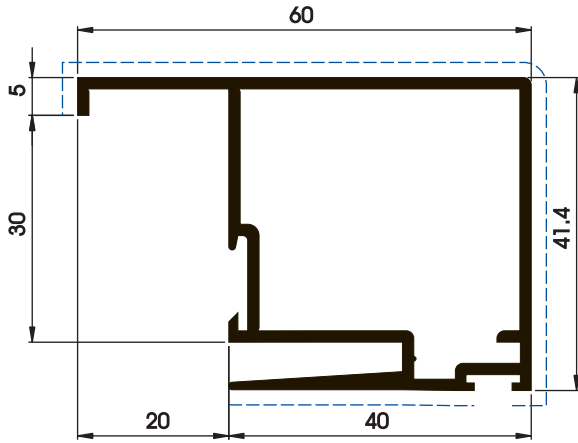

**P03081**  
0,876 kg/m      0,274 m<sup>2</sup>/m

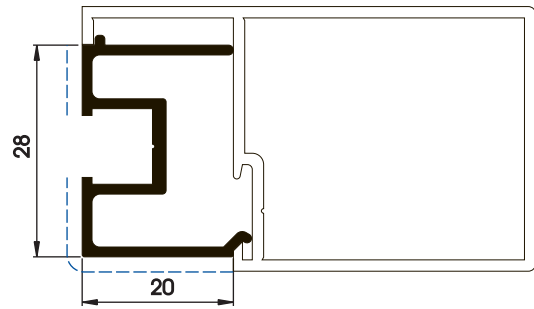

**P03169**  
0,335 kg/m      0,182 m<sup>2</sup>/m

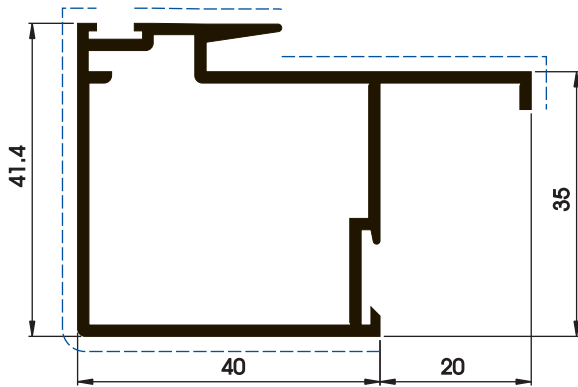

**P03080**  
0,815 kg/m      0,248 m<sup>2</sup>/m

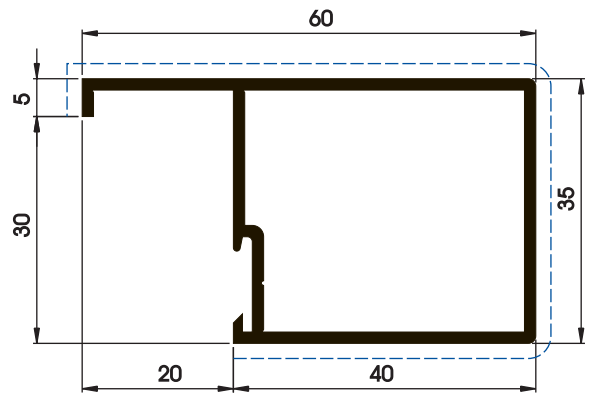

**P03079**  
0,700 kg/m      0,208 m<sup>2</sup>/m

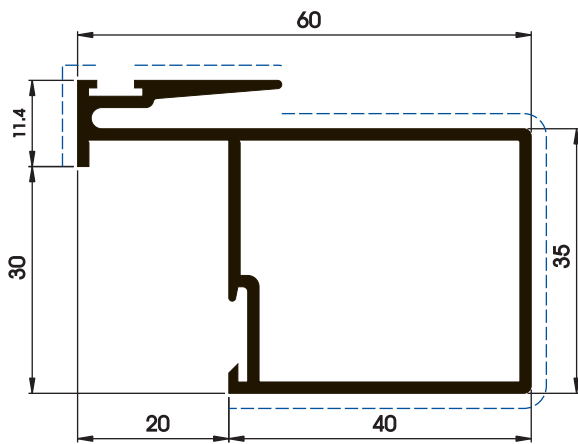

**P03244**  
0,854 kg/m      0,277 m<sup>2</sup>/m

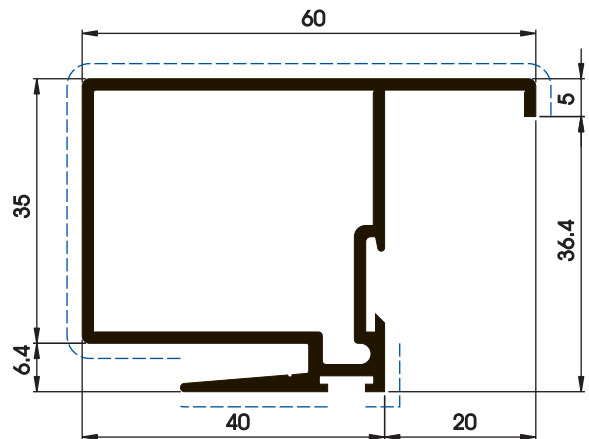

**P03243**  
0,854 kg/m      0,276 m<sup>2</sup>/m

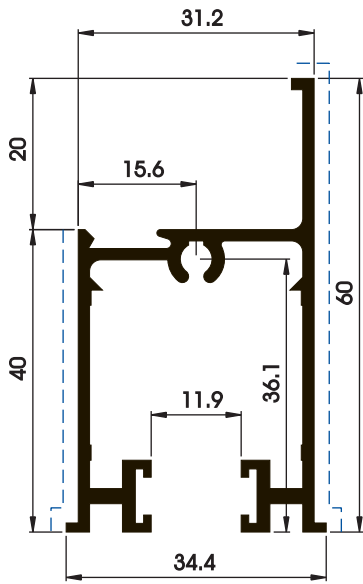

**P03082**  
0,785 kg/m  
0,376 m<sup>2</sup>/m

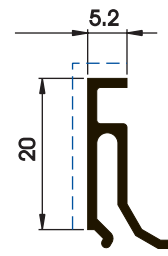

**P03086**  
0,165 kg/m  
0,102 m<sup>2</sup>/m

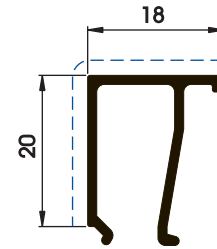

**P03085**  
0,210 kg/m  
0,128 m<sup>2</sup>/m

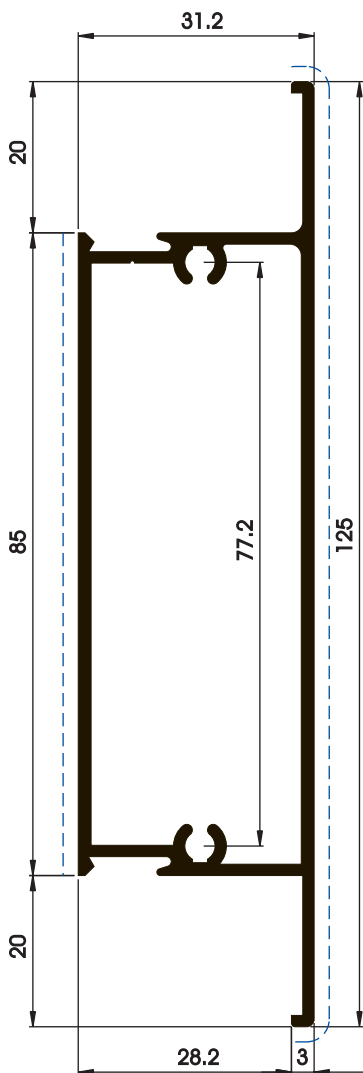

**P03083**  
1,300 kg/m  
0,333 m<sup>2</sup>/m

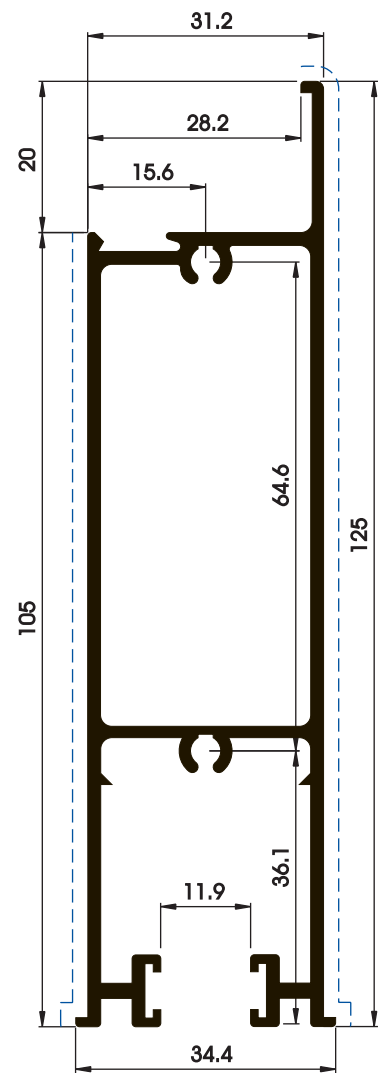

**P03084**  
1,570 kg/m  
0,504 m<sup>2</sup>/m

# SÉRIE DE CORRER P3

H A Portalex

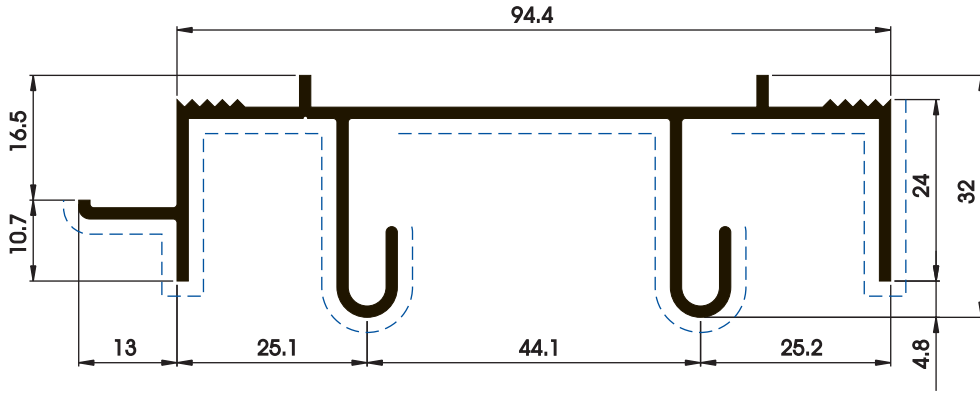

**P03322**  
0,998 kg/m  
0,491 m<sup>2</sup>/m

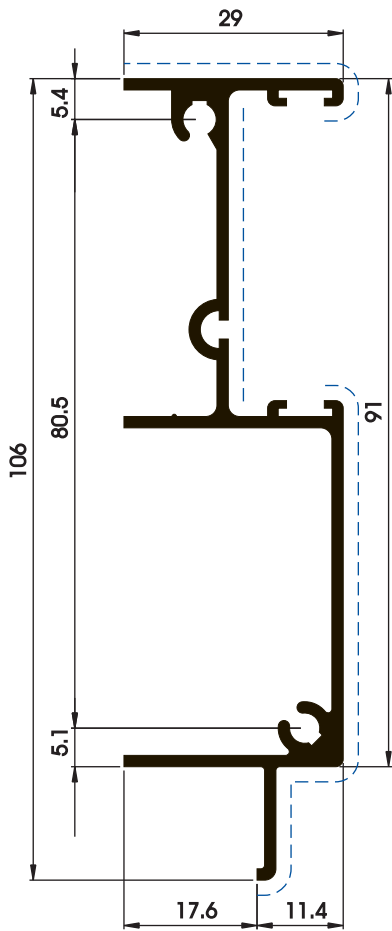

**P03323**  
0,967 kg/m  
0,438 m<sup>2</sup>/m

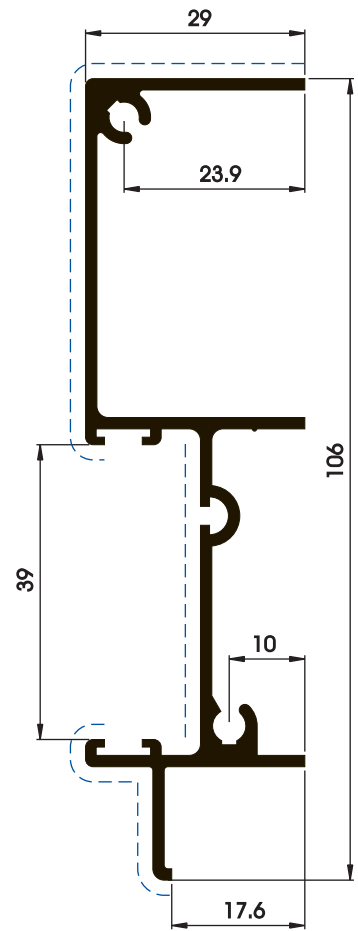

**P03324**  
0,967 kg/m  
0,438 m<sup>2</sup>/m

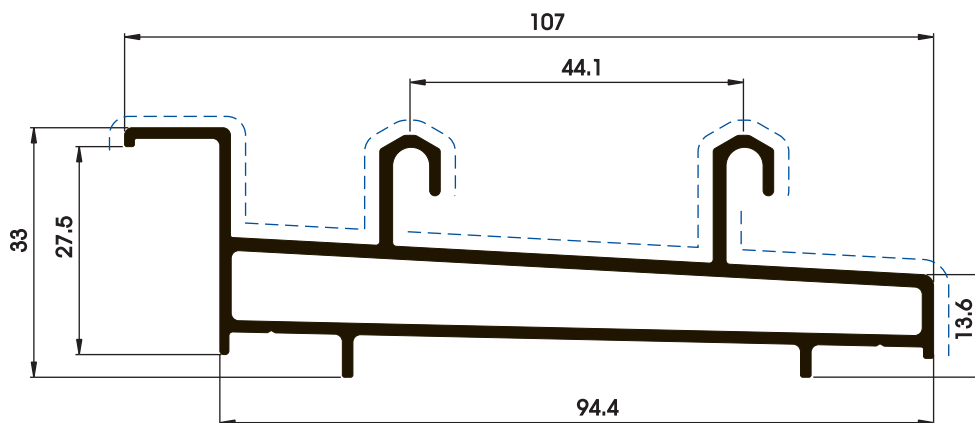

P04856

1,268 kg/m

0,393 m<sup>2</sup>/m

Este catálogo poderá ser sujeito a alterações por motivos técnicos, sem aviso prévio.  
Qualquer encomenda deverá ser sujeita a confirmação com os nossos serviços.

# H A Portalex

SEDE: Estr. S. Marcos, 23 – 2735-521 Cacém  
PORTUGAL  
Telef.: (+351) 21 041 25 00  
Fax: (+351) 21 041 25 28  
Fax Dir. Comercial: (+351) 21 041 25 07

AVA: Lugar de S. Carlos  
2726-901 Mem Martins  
PORTUGAL  
Telef.: (+351) 21 041 24 00  
Fax: (+351) 21 041 24 29

Contribuinte nº 500396361  
Registo Comercial de Sintra nº 1709  
Capital Social: EUR 1.483.850,00  
[www.hydro.com/extrusion/portugal](http://www.hydro.com/extrusion/portugal)