

# Boletim Técnico #41

Inclusão de portinhola - Linha Universal Portão



## Atualizações técnicas:

Tipologias.....	Pág 02
Perfis .....	Pág 03
Componentes .....	Pág 06
Montagens.....	Pág 07

## Tipologias - Inclusão de portinhola.....

Produto destinado somente para portinholas de depósito de lixos, cabine de leitura de gás, água, energia.

Não pode ser utilizado como portas de giro.

### Portinhola de 1 folha

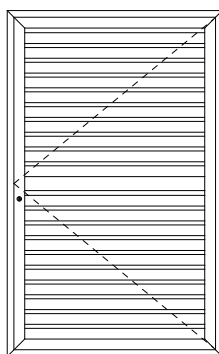

### Portinhola de 2 folhas

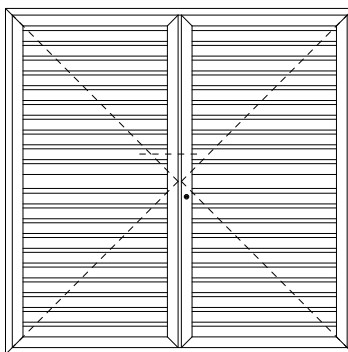

### Portinhola de 2 folhas com lambris

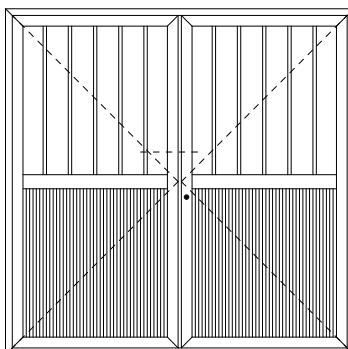

**Perfis**.....

Produto destinado somente para portilholas de depósito de lixos, cabine de leitura de gás, água, energia.

**Não pode ser utilizado como portas de giro.**

**LU006** 0,269 Kg/m

Marco perimetral

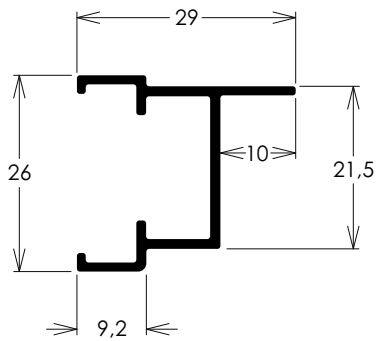

**LU005** 0,126 Kg/m

Mata junta

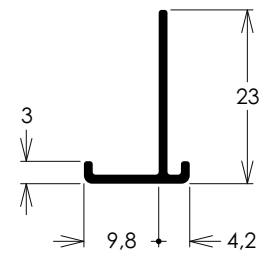

**LU003** 0,274 Kg/m

Marco perimetral

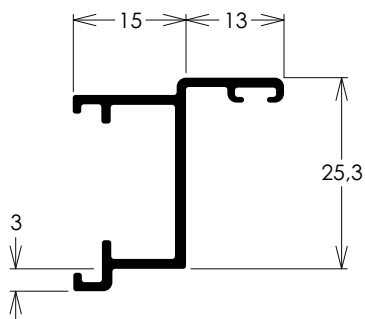

**LU007** 0,441 Kg/m

Perfil da folha com 47 mm

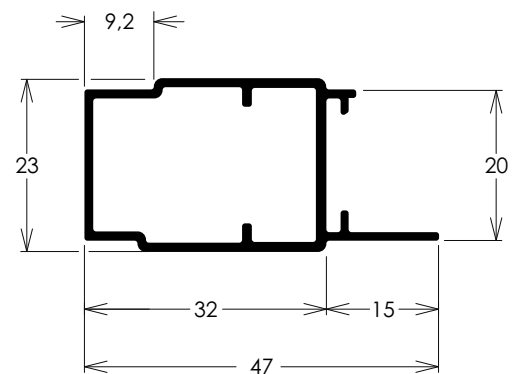

**LU004** 0,499 Kg/m

Perfil da folha com 56 mm

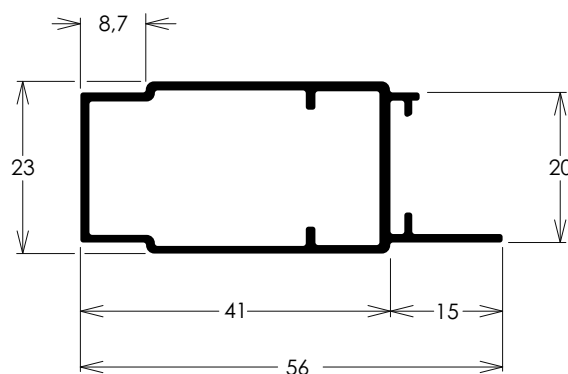

**Perfis**.....

Produto destinado somente para portilholas de depósito de lixos, cabine de leitura de gás, água, energia.

**Não pode ser utilizado como portas de giro.**

**VZ072** 0,260 Kg/m

Palheta veneziana cega

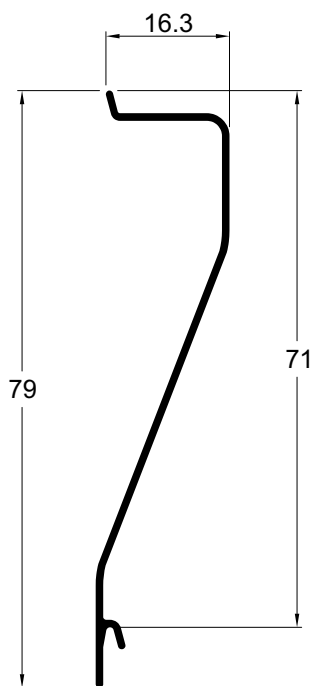

**US620** 0,260 Kg/m

Palheta veneziana ventilada

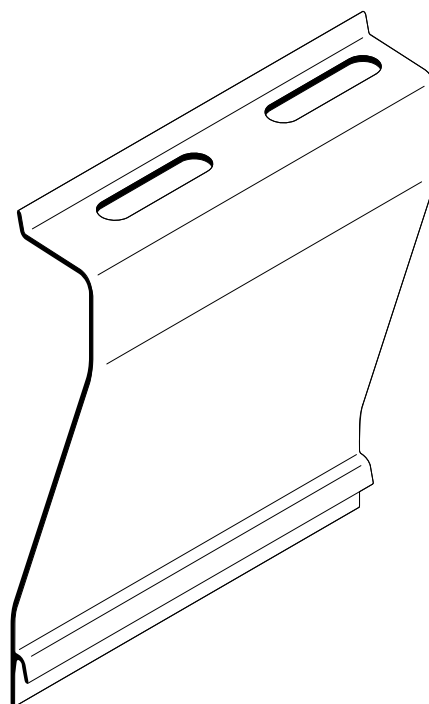

**MH087** 0,253 Kg/m

Palheta veneziana cega

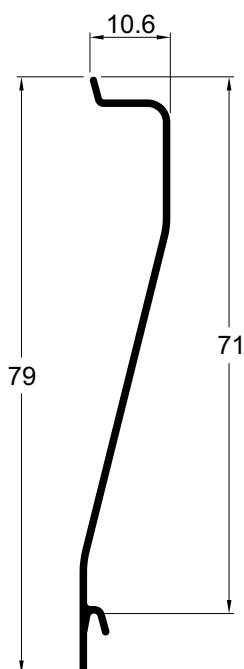

**US624** 0,253 Kg/m

Palheta veneziana ventilada

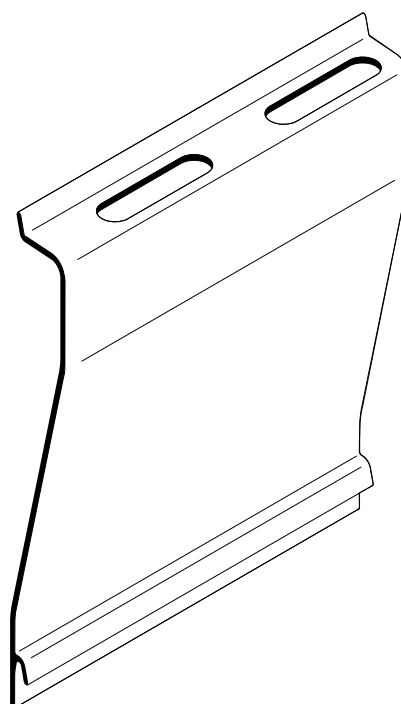

## Perfis.....

Produto destinado somente para portilholas de depósito de lixos, cabine de leitura de gás, água, energia.

**Não pode ser utilizado como portas de giro.**

### MH014 0,114 Kg/m

Baguete trav. para vidro de 3 e 4 mm

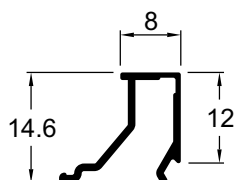

### MH015 0,110 Kg/m

Baguete mont. para vidro de 3 e 4 mm

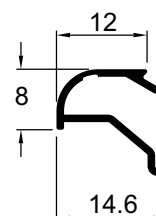

### MH107 0,107 Kg/m

Baguete trav. para vidro de 5 e 6 mm

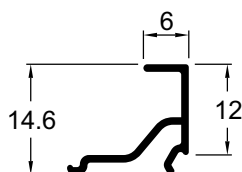

### MH108 0,101 Kg/m

Baguete mont. para vidro de 5 e 6 mm

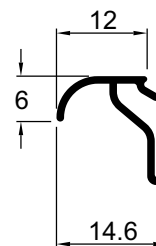

### MH041 0,109 Kg/m

Complemento para veneziana

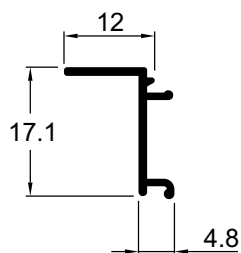

### CM200 0,198 Kg/m

Requadro em alumínio natural

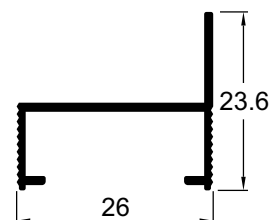

### CL006 1,112 Kg/m

Conexão macho

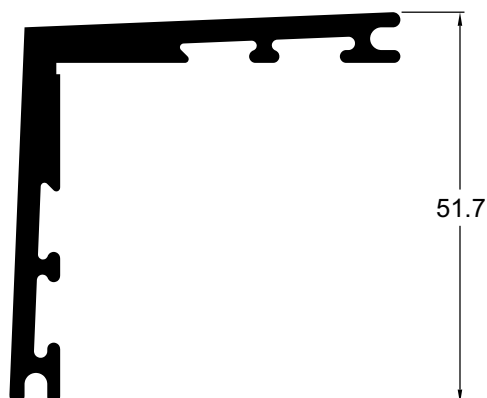

### CL011 0,317 Kg/m

Conexão cunha

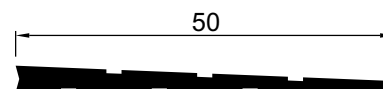



# Montagens.....

Produto destinado somente para portinholas de depósito de lixos, cabine de leitura de gás, água, energia.  
**Não pode ser utilizado como portas de giro.**



## ELEVAÇÕES VISTAS EXTERNAS

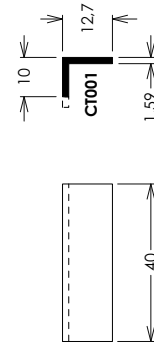
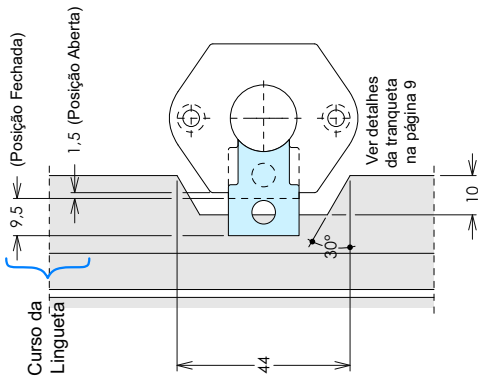
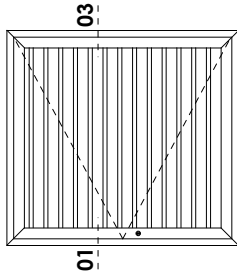
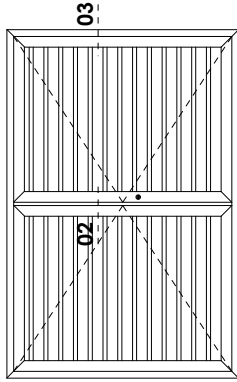

Contrafecho

Medidas de Conexões	
Perfil	Medida
CM200	23 mm
LU006	18,5 mm
LU007	20 mm

Uso do perfil LU007 com diferentes baguetes

Usinagem da aba do Marco

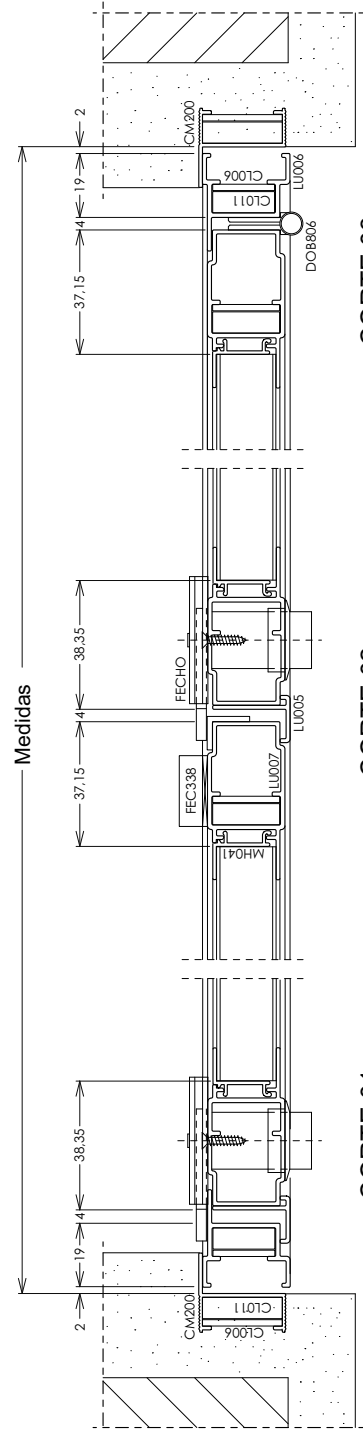

Portinhola com tranqueta com chave

LADO EXTERNO





[hydro.com/brasil](https://hydro.com/brasil)



[@hydronobrasil](https://www.facebook.com/hydronobrasil)



[@hydronobrasil](https://www.instagram.com/hydronobrasil)



[Norsk Hydro](https://www.linkedin.com/company/Norsk-Hydro)



[hydronobrasil](https://www.youtube.com/hydronobrasil)